

Whirlpool

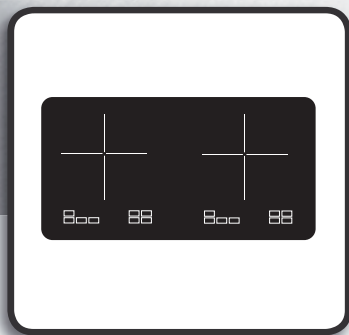

## Health & Safety, Use & Care, Installation Guide and Online Warranty Registration Information

產品安全指引、使用說明、安裝指南及  
網上登記保養資料

Model 產品型號 : IWHL7320SC  
IWHH7320SH



[www.whirlpool.com.hk](http://www.whirlpool.com.hk)  
[www.whirlpool.com.sg](http://www.whirlpool.com.sg)



# INDUCTION COOKTOP USE AND CARE GUIDE

Dear User,

Thank you for choosing our products. We are sure you will find your new appliance a pleasure to use. Before you use the appliance, we recommend that you read through these instructions carefully and retain for future reference. Design and specification may change due to product development, no prior notice will be given.

## Table of Contents

|                                           |    |
|-------------------------------------------|----|
| Safety Instructions -----                 | 3  |
| Installations -----                       | 5  |
| Operation Instructions -----              | 10 |
| Power Sharing Management -----            | 13 |
| Stir-fry -----                            | 13 |
| Keep Warm -----                           | 14 |
| Booster -----                             | 14 |
| Child Lock Safety Control -----           | 15 |
| Stop & Go -----                           | 15 |
| Timer -----                               | 16 |
| Detection of Pan and Small Articles ----- | 16 |
| Residual Heat Warning -----               | 17 |
| Auto Shutdown -----                       | 17 |
| Over-heat Protection -----                | 17 |
| Over-flow Protection -----                | 17 |
| Cooking Guidelines -----                  | 17 |
| Cooking Tips -----                        | 18 |
| Cleaning And Maintenance -----            | 19 |
| Troubleshooting -----                     | 22 |

---

# IMPORTANT SAFETY INSTRUCTIONS

---

## SAFETY INSTRUCTIONS IMPORTANT TO BE READ AND OBSERVED

Download the complete instruction manual on Whirlpool official website or call the phone number shown on the official website.

Before using the appliance, read these safety instructions. Keep them nearby for future reference. These instructions and the appliance itself provide important safety warnings, to be observed at all times. The manufacturer declines any liability for failure to observe these safety instructions, for inappropriate use of the appliance or incorrect setting of controls.

 **WARNING:** If the cooktop surface is cracked, do not use the appliance - risk of electric shock.

 **WARNING:** Danger of fire: Do not store items on the cooking surfaces.

 **CAUTION:** The cooking process has to be supervised. A short cooking process has to be supervised continuously.

 **WARNING:** Unattended cooking on a cooktop with fat or oil can be dangerous - risk of fire. Never try to extinguish a fire with water: instead, switch off the appliance and then cover flame e.g. with a lid or a fire blanket.

 Do not use cooktop as a work surface or support. Keep clothes or other flammable materials away from the appliance, until all the components have cooled down completely - risk of fire.

 Metallic objects such as knives, forks, spoons and lids should not be placed on the cooktop surface since they can get hot.

 Very young children (0-3 years) should be kept away from the appliance. Young children (3-8 years) should be kept away from the appliance unless continuously supervised. Children from 8 years old and above and persons with reduced physical, sensory or mental capabilities or lack of experience and knowledge can use this appliance only if they are supervised or have been given instructions on safe use and understand the hazards involved. Children must not play with the appliance. Cleaning and user maintenance must not be carried out by children without supervision.

 After use, switch off the cooktop element by its control and do not rely on the pan detector.

 **WARNING:** The appliance and its accessible parts become hot during use. Care should be taken to avoid touching heating elements. Children less than 8 years of age shall be kept away unless continuously supervised.

## PERMITTED USE

 **CAUTION:** the appliance is not intended to be operated by means of an external switching device, such as a timer, or separate remote controlled system.

 This appliance is intended to be used in household and similar applications such as: staff kitchen areas in shops, offices and other working environments; farm houses; by clients in hotels, motels, bed & breakfast and other residential environments.

 No other use is permitted (e.g. heating rooms).

 This appliance is not for professional use. Do not use the appliance outdoors.

## INSTALLATION

 The appliance must be handled and installed by two or more persons - risk of injury. Use protective gloves to unpack and install - risk of cuts.

 Installation, including water supply (if any), electrical connections and repairs must be carried out by a qualified technician. Do not repair or replace any part of the appliance unless specifically stated in the user manual. Keep children away from the installation site. After unpacking the appliance, make sure that it has not been damaged during transport. In the event of problems, contact the dealer or your nearest After-sales Service. Once installed, packaging waste (plastic, styrofoam parts etc.) must be stored out of reach of children - risk of suffocation. The appliance must be disconnected from the power supply before any installation operation - risk of electric shock. During installation, make sure the appliance does not damage the power cable - risk of fire or electric shock. Only activate the appliance when the installation has been completed.

 Carry out all cabinet cutting operations before fitting the appliance and remove all wood chips and sawdust.

 If the appliance is not installed above an oven, a separator panel (not included) must be installed in the compartment under the appliance.

## ELECTRICAL WARNINGS

 It must be possible to disconnect the appliance from the power supply by unplugging it if plug is accessible, or by a multi-pole switch installed upstream of the socket in accordance with the wiring rules and the appliance must be earthed in conformity with national electrical safety standards.

 Do not use extension leads, multiple sockets or adapters. The electrical components must not be accessible to the user after installation. Do not use the appliance when you are wet or barefoot. Do not operate this appliance if it has a damaged power cable or plug, if it is not working properly, or if it has been damaged or dropped.

 If the supply cord is damaged, it must be replaced with an identical one by the manufacturer, its service agent or similarly qualified persons in order to avoid a hazard - risk of electric shock.

## CLEANING AND MAINTENANCE

 **WARNING:** Ensure that the appliance is switched off and disconnected from the power supply before performing any maintenance operation; never use steam cleaning equipment - risk of electric shock.

 Do not use abrasive or corrosive products, chlorine-based cleaners or pan scourers.

## ENERGY SAVING TIPS

Make the most of your hot plate's residual heat by switching it off a few minutes before you finish cooking. The base of your pot or pan should cover the hot plate completely; a container that is smaller than the hot plate will cause energy to be wasted.

Cover your pots and pans with tight-fitting lids while cooking and use as little water as possible. Cooking with the lid off will greatly increase energy consumption.

Use only flat-bottomed pots and pans.

## NOTE

People with a pacemaker or similar medical device should use care when standing near this induction cooktop while it is on. The electromagnetic field may affect the pacemaker or similar device. Consult your doctor, or the manufacturer of the pacemaker or similar medical device for additional information about its effects with electromagnetic fields of the induction cooktop.

---

## INSTALLATIONS

---

### Installation Instructions

The appliance must be installed and connected in accordance with current regulations. After unpacking the appliance, ensure there is no visible damage. If it has been damaged during transit, DO NOT USE, contact where you buy immediately.

### Selection of installation equipment

Cut out the work surface according to the sizes shown in the drawing.

For the purpose of installation and use, a minimum of 5 cm space shall be preserved around the hole. Be sure the thickness of the work surface is at least 30mm. Please select heat-resistant work surface material to avoid larger deformation caused by the heat radiation from the hotplate. As shown below:

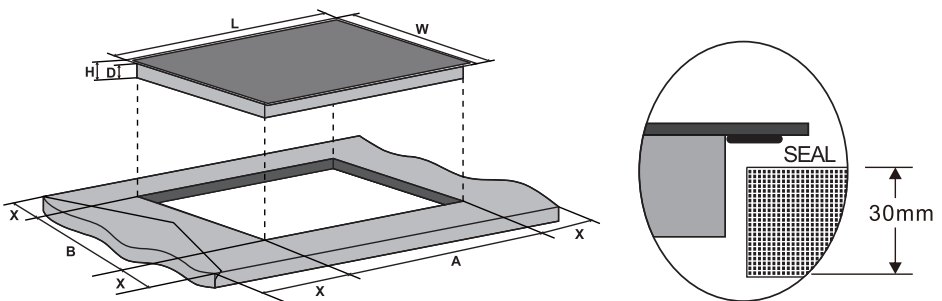

| Model                    | L<br>(mm) | W<br>(mm) | H<br>(mm) | D<br>(mm) | A<br>(mm) | B<br>(mm) | X-min<br>(mm) |
|--------------------------|-----------|-----------|-----------|-----------|-----------|-----------|---------------|
| IWHH7320SH<br>IWHL7320SC | 730       | 430       | 60        | 54        | 660       | 390       | 50            |

Under any circumstances, make sure the electric cooktop is well ventilated and the air inlet and outlet are not blocked. Ensure the electric cooktop is in good work state. As shown below:



Note: The safety distance between the hotplate and the cupboard above the hotplate should be at least 760mm.

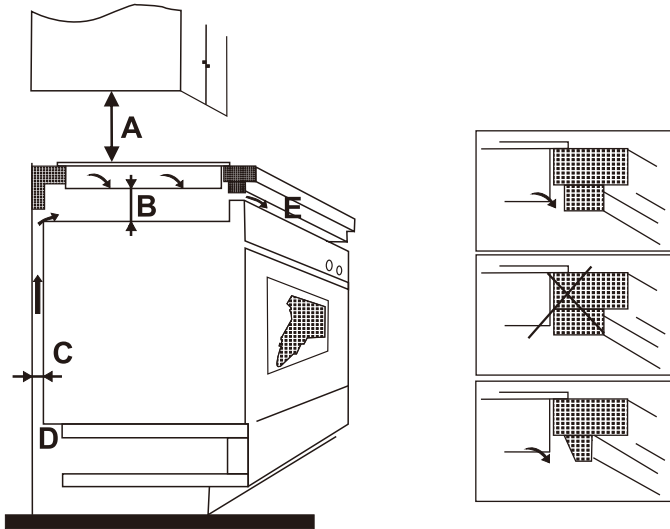

| A<br>(mm)   | B<br>(mm)  | C<br>(mm)  | D<br>(mm)                | E<br>(mm)             |
|-------------|------------|------------|--------------------------|-----------------------|
| 760 minimal | 50 minimal | 20 minimal | Air intake<br>20 minimal | Air exit<br>5 minimal |

## Installing the foam gasket

Before inserting the cooktop into the opening in the kitchen worktop, the supplied foam gasket (in a plastic bag) must be attached to the lower side of the ceramic glass.

**Do not install the cooktop without the foam gasket! The gasket should be attached to the cooktop in the following method:**

- Remove the protective film from the gasket.
- Then attach the gasket to the lower side of the glass, next to the edge.

- The gasket must be attached along the entire length of the glass edge and should not overlap at the corners.
- When installing the gasket, make sure that the glass does not come into contact with any sharp objects.

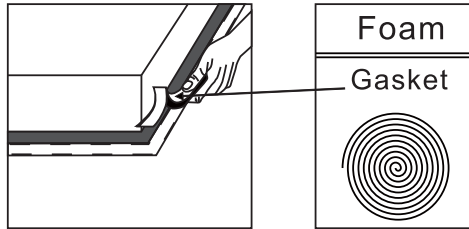

### Fix cooktop to cabinet

The unit should be placed on a stable, smooth surface (use the packaging). Do not apply force onto the controls protruding from the cooktop.

Insert the cooktop into the cabinet/work surface as below diagrams to secure your cooktop sturdily.

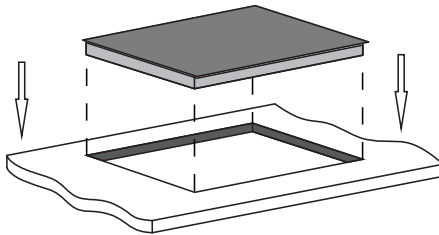

### Locating the flexible cut fixing brackets

- Fix the hob on the work surface by screw four brackets on the bottom of hob (see picture) after installation.
- Adjust the bracket position to suit for different work surface's thickness.

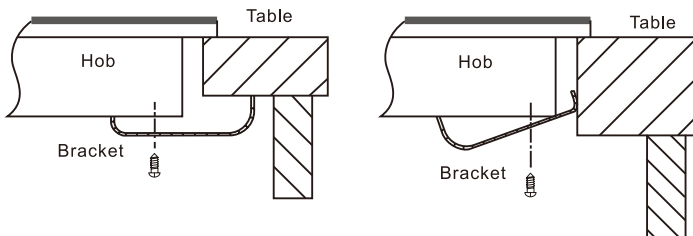

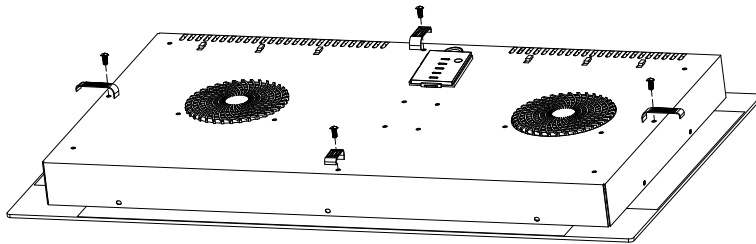

### Rubber Feet

IWHL7320SC has rubber feet. There are 4pcs feet and 4pcs screws have been assembled on the hob in factory.

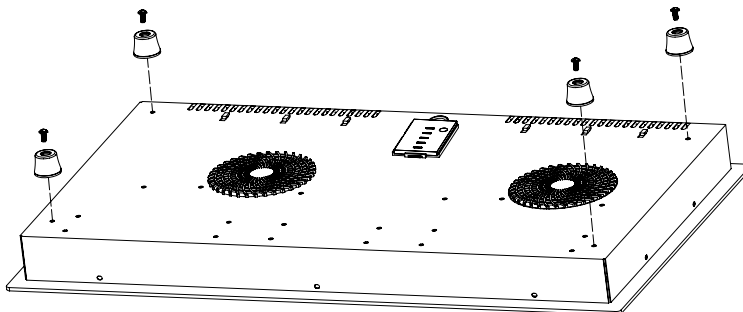

### Connecting the cooktop to the mains power supply

The power supply should be connected in compliance with the relevant standard, or a single-pole circuit breaker. **The appliance has a large power rating and must be connected to electricity by a Qualified Electrician.** Notes:

1. If the cable is damaged or needs replacing, this should be done by an after-sales technician using the proper tools, so as to avoid any accidents.
2. If the appliance is being connected directly to the mains supply, an omni polar circuit breaker must be installed with a minimum gap of 3mm between the contacts.
3. The installer must ensure that the correct electrical connection has been made and that it complies with safety regulations.
4. The cable must not be bent or compressed.
5. The cable must be checked regularly and only replaced by qualified technician.

### Cautions

1. **The cooktop must be installed by qualified personnel or technicians.** Please never conduct the operation by yourself.
2. The electric cooktop shall not be mounted to cooling equipment, dishwashers and rotary dryers.
3. The electric cooktop shall be installed such that better heat radiation can be ensured to enhance its reliability.
4. The wall and induced heating zone above the work surface shall withstand heat.



- 5. To avoid any damage, the sandwich layer and adhesive must be heat resistant.
- 6. A steam cleaner is not to be used.

**Note:** For IWHL7320SC applied with a power cord with plug. If so, you can directly plug in socket. Please keep power cord plug out after use.

**For model IWHL7320SH, power cord without plug, the method of connections shown below.**

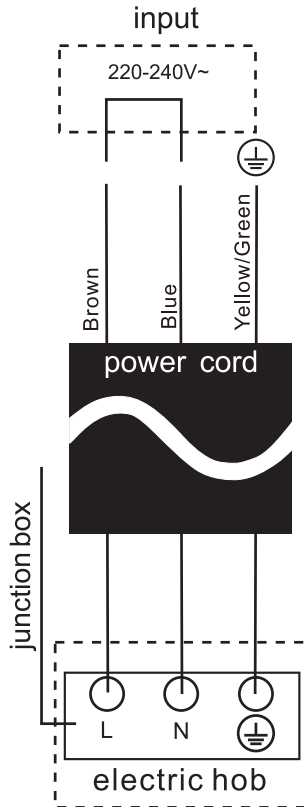

---

# OPERATION INSTRUCTIONS

---

Model: IWHL7320SC, IWHH7320SH

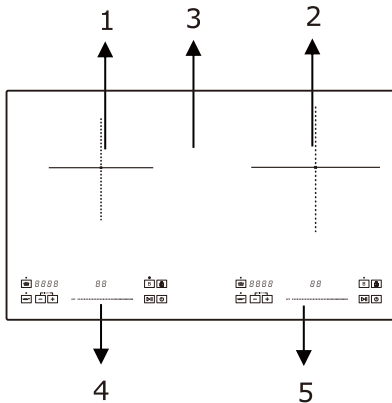

1. 2200W booster 2800W induction Zone
2. 2200W booster 2800W induction Zone
3. Ceramic Glass
4. Control panel of cooking zone#1
5. Control panel of cooking zone#2

## Control Panel

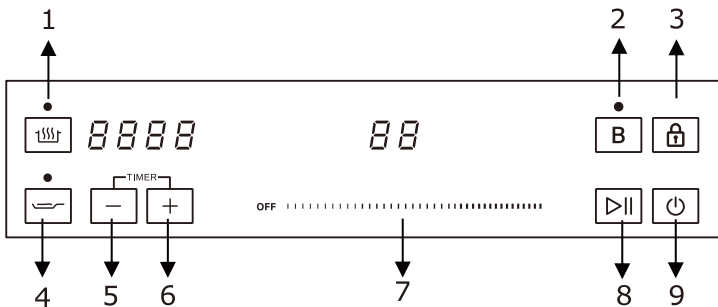

1. Keep Warm control button
2. Booster
3. Child Lock control button
4. Stir-fry control button
- 5/6. Timer control -/+ button
7. Heating level slider control
8. Stop & Go (Pause)
9. ON/OFF

**Notes:** Product diagrams in the manual for reference only, there might be slightly difference due to continually product improvements.

## Before Using Your New Cooktop

- Read this guide, taking special note of the 'Safety Warnings' section.
- Remove any protective film that may still be on your new electric cooktop.

## Using the Touch Controls

- The controls respond to touch, so you don't need to apply any pressure.
- Use the ball of your finger, not its tip.
- You will hear a beep each time a touch is registered.
- Make sure the controls are always clean, dry, and that there is no object (e.g. a utensil or a cloth) covering them. Even a thin film of water may make the controls difficult to operate.

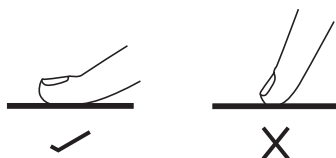

## Choose the Right Cookware



- Only use cookware with a base suitable for induction cooking. Look for the induction symbol on the packaging or on the bottom of the pan.

- You can check whether your cookware is suitable by carrying out a magnet test. Move a magnet towards the base of the pan. If it is attracted, the pan is suitable for induction cooktop.
- If you do not have a magnet:

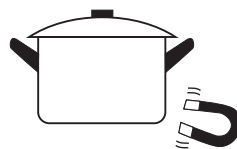

1. Put some water in the pan you want to check.
  2. If **H** does not flash in the display and water is heating, the pan is suitable.
- Cookware made from the following materials is not suitable for an induction cooktop: pure stainless steel, aluminum or copper without a magnetic base, glass, wood, porcelain, ceramic, and earthenware.
  - Induction cooktop are made from smooth, ceramic glass, the heat comes from a magnetic induction coil which heats the cookware but not the cooking surface. The heat from the cookware is transferred to the food.
  - It's important that you use only metal pans specifically designed and/or approved for use on induction cooktop. Never allow melamine or plastic containers to come in contact with the heat zones.
  - A pan which diameter less than 140mm may not be detected by the induction cooktop. Do not use cookware with jagged edges or a curved base.



Make sure that the base of your pan is smooth, sits flat against the glass, and is the same size as the cooking zone. If you use smaller pot efficiency could be less than expected. Always centre your pan on the cooking zone.

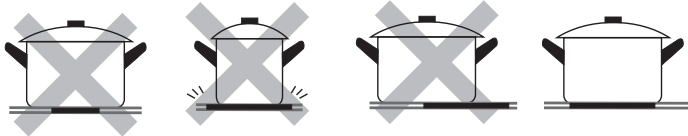

Always lift pans off the cooktop – do not slide, or they may scratch the glass.

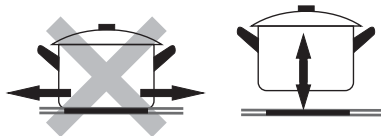

## Suggested Pan dimensions for induction cooktop

The cooking zones are, up to a limit, automatically adapted to the diameter of the pan. However, the bottom of this pan is suggested to have a minimum of diameter according to the corresponding cooking zone. To obtain the best efficiency of your cooktop, please place the pan in the centre of the cooking zone.

Base diameter of the pots:

| <i>Cooking zone</i> | <i>Minimum (mm)</i> | <i>Maximum (mm)</i> |
|---------------------|---------------------|---------------------|
| 210mm               | 140                 | 210                 |

## Using Your Cooktop

### To start cooking

1. After the cooktop be connected to electricity and power on. **Press and hold the ON/OFF  control button for about 3 seconds till you hear a “beep” to turn the cooktop on.** Now the cooktop enters into Standby mode, all heat setting indicators and Timer setting indicators shows “-”
2. Place a suitable pan on the cooking zone you wish to use. Make sure the bottom of the pan and the surface of the cooking zone are clean and dry.

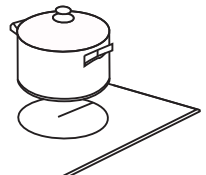

3. Set heating level of cooking zone. You can adjust heat setting from 0-12 by touching the slider control.

OFF |||

**Notes:**

- 1. After connect to electricity, when power on, the buzzer of cooktop beeps once, all indicators light up for 1 second then go out.
- 2. When the cooktop in Standby mode, if there is no practice within 1 minute, the electric cooktop will auto turn off, with buzzer beeps once.
- 3. To turn on cooktop, press the ON/OFF control button and hold on for about 3 seconds; To turn it off, just need to press ON/OFF button again.
- 4. The power level can be adjusted from 0 to 12.
- 5. The heat setting indicator of the selected zone flashing when adjusting. After adjusting, the number flashing for 5 seconds then stop flashing, then the setting is confirmed.

### To turn off cooktop

- 1. You can turn the cooking zone off by adjust heat setting to level 0, which the power level display LED shows "--".
- 2. You can also turn the whole cooktop off by touching the ON/OFF  control button.



**Note:** If there is power cut off during cooking, all setting will be cancelled. **Note:** The cooling fan of induction cooktop will remain on for about 1 minute after the cooktop be turned off.

### Power Sharing Management

Your hob is with power management function, this function will limit total power within **4400W (IWHH7320SH) & 2800W (IWHL7320SC)**. When 2 cooking zones working together and total power reach 4400W/2800W, if you want to increase power level of a cooking zone, the programmer will auto turn down power level or switch off the other cooking zone to keep total power within this setting.

### Using Stir-fry Function

**IWHL7320SC, IWHH7320SH** have Stir-fry function, which could switch cooking zone to maximum temperature level to reduce your cooking time.

To active Stir-fry function **when cooktop is working**, please follows below: 1. Directly touch Stir-fry function button  of the cooking zone you wish to use.

**Notes:**

- 1. By single touch Stir-fry function button, the cooktop works at maximum temperature level 260°C.
- 2. When Stir-fry function active, the Stir-fry function indicator is lit up.
- 3. By touching stir-fry function button again, will cancel the Stir-fry function.

## Using Keep Warm Function

**IWHL7320SC, IWHH7320SH** come with Keep Warm function, which makes it very convenient to keep food at desired temperature in a period of time.

To active Keep Warm function **when cooktop is working**, please follows below:

1. Touching keep warm function button  of the cooking zone you wish to use.
2. The default temperature setting is 45°C, while you can press the keep warm function button again to adjust it from 45,65, 85°C in circle depend on the temperature you wish.

### Notes:

1. In keep warm function, the cooktop works at default temperature level 45°C.
  2. When keep warm function active, the keep warm function indicator is on.
  3. By continuous touch the keep warm control button, the cooking zone works at below consequence:
    - Cooking zone: “45°C-65°C-85°C-Cancel-45°C-65°C-85 -Cancel...”
- Cancel Keep Warm function**
1. Touching the keep warm control button again until it cancels the keep warm function, then the cooking zone will revert to its original power setting.
  2. You will have to cancel keep warm function first then you can switch to Stir-fry or Booster function.

## Using Booster Function

**IWHL7320SC, IWHH7320SH** have two cooking zones which have Booster function. You can use the “Booster” function to boost power of relevant cooking zone for a maximum power output for 5 minutes. This function could reduce the cooking time, which convenience for cooking when in hurry!

**To use booster function when cooktop is working, follows below:**

1. Active the cooking zone you want to use booster function.
2. Touch the Booster function control button , the heating zone indicator will show “b” and flashing for 5 seconds then stop flashing, then Booster function be activated.

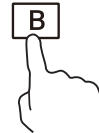

### Note:

1. After booster finish, the cooking zone will return to original setting.

### Cancel the Booster function

- Follow above practice of active Booster function one more time when Booster is working, could cancel the Booster function.
- You can also cancel Booster function by adjust power level setting.

## Child Lock Safety Control

- You can lock the controls to prevent unintended use (for example children accidentally turning the cooking zones on) by active Child Lock function.
- When the controls are locked, except the ON/OFF control button and Child Lock control button, all other touch control buttons are disabled.



### To lock the controls

Touch the Child Lock control button  once. The timer indicator will show “Lo”, and Child and Lock function be active.

### To unlock the controls

1. Make sure the electric cooktop is turned on.
2. Touch and hold the Child Lock control button  for 3 seconds, the buzzer beeps once and “Lo” disappears in timer indicator, the Child Lock be inactive.
3. You can now start using your electric cooktop.



Under the child lock mode, all controls button be disable except the ON/OFF button  and child lock  button.

You can always turn the cooktop off with the ON/OFF  control in an emergency, but you shall unlock the cooktop first in the next operation

**Note:** Under Child Lock function, if turn the cooktop off without inactive the Child Lock function. When turn on the cooktop later, the Child Lock function will still valid and the cooktop cannot start.

## Stop & Go function

- **Make cooking easy!** When cooking, your doorbell rings, phone rings, or kid shouts from another door. Need to step out of kitchen? These means dinner could burn, or take longer time to ready if you switch everything off.
- The **Stop & Go function** can turn off all zones. When you back, with one more touching of the button , cooktop restarts where they were, to carry on cooking.

### 1. Active Stop & Go function

To active **Stop & Go** function, you can press the **Stop & Go** function button once. Then all programmer setting be hold on and cooktop stop heating, all heat setting indicators show “P”.

### 2. Inactive Stop & Go function

To cancel **Stop & Go** function, you can press the **Stop & Go** function again, after come back. Then all programmer setting will return to what they were, Stop & Go indicator “P” disappear from all indicators.

When **Stop & Go** function active, all control buttons are disable except the

ON/OFF, Child Lock and Stop & Go button.



**Note:** The cooktop will auto turn off, if Stop & Go function last more than 10 minutes.





**Notes:**

1. No heating takes place unless there is a suitable pan on the cooking zone.
2. The display will auto turn off after 2 minutes if no suitable pan is placed on it.
3. When an unsuitable size or non-magnetic pan (e.g. aluminum), or some other small item (e.g. knife, fork, key) has been left on the cooktop, the corresponding cooking zone will automatically turn off in 1 minute.

**Residual Heat Warning****Beware of hot surfaces**

When the cooktop has been operating for some time, there will be some residual heat. The letter “ H ” appears in timer display LED to warn you to keep away from it.

**It can also be used as an energy saving function:**

if you want to heat further pans, use the hotplate that is still hot.

**Auto Shutdown**

Another safety feature of the cooktop is auto shutdown. This occurs whenever you forget to switch off a cooking zone.

The default shutdown times (hour) as below table:

|                      |   |   |   |   |   |   |   |   |   |    |    |    |
|----------------------|---|---|---|---|---|---|---|---|---|----|----|----|
| Power level          | 1 | 2 | 3 | 4 | 5 | 6 | 7 | 8 | 9 | 10 | 11 | 12 |
| Default working time | 8 | 8 | 8 | 8 | 4 | 4 | 4 | 4 | 2 | 2  | 2  | 2  |

**Over-heat Protection**

A temperature sensor equipped can monitor the temperature inside the cooktop. When an excessive temperature is monitored, the cooktop will auto stop operation.

**Over-flow Protection**

For your safety, the programmer will auto shut off the power if liquid boiling or wet cloth over touch control panel. All control buttons became invalid except ON/OFF and Child Lock button, unless you wipe the touch control area dry.

**Cooking Guidelines**

Take care when frying as the oil and fat heat up quickly, particularly if you are using Booster function. At extremely high temperature oil and fat will ignite spontaneously and this presents a risk of fire.

## **Cooking Tips**

- When food comes to the boil, reduce the power setting.
- Using a lid will reduce cooking times and save energy by retaining the heat.
- Minimize the amount of liquid or fat to reduce cooking times.
- Start cooking on a high setting and reduce the setting when the food has heated through.

### **Simmering, cooking rice**

- Simmering occurs below boiling point, at around 85°C, when bubbles are just rising occasionally to the surface of the cooking liquid. It is the key to delicious soups and tender stews because flavors develop without overcooking the food. You should also cook egg-based and flour thickened sauces below boiling point.
- Some tasks, including cooking rice by the absorption method, may require a setting higher than the lowest setting to ensure the food is cooked properly in the time recommended.

### **Searing steak**

To cook juicy flavorsome steaks:

1. Stand the meat at room temperature for about 20 minutes before cooking.
2. Heat up a heavy-based frying pan.
3. Brush both sides of the steak with oil. Drizzle a small amount of oil into the hot pan and then lower the meat onto the hot pan.
4. Turn the steak only once during cooking. The exact cooking time will depend on the thickness of the steak and how cooked you want it. Times may vary from about 2 – 8 minutes per side. Press the steak to gauge how cooked it is – the firmer it feels the more ‘well done’ it will be.
5. Leave the steak to rest on a warm plate for a few minutes to allow it to relax and become tender before serving.

### **For stir-frying**

1. Choose a ceramic compatible flat-based wok or a large frying pan.
2. Have all the ingredients and equipment ready. Stir-frying should be quick. If cooking large quantities, cook the food in several smaller batches.
3. Preheat the pan briefly and add two tablespoons of oil.
4. Cook any meat first, put it aside and keep warm.
5. Stir-fry the vegetables. When they are hot but still crisp, turn the cooking zone to a lower setting, return the meat to the pan and add your sauce.
6. Stir the ingredients gently to make sure they are heated through.
7. Serve immediately.

---

## CLEANING AND MAINTENANCE

---

**Important:** Before any maintenance or cleaning work is carried out, **DISCONNECT** the appliance from **ELECTRICITY** supply and ensure the appliances is **completely cool**.

### Cleaning the Cooktop Surface

Clean spillages from the cooktop surface as soon as possible after use. Always ensure the surface is cool enough before cleaning.

- Use a soft cloth or kitchen paper to clean the surface. If the spillage has dried on the surface, you may need to use a specialist vitro-ceramic glass cleaner, which is available for most of supermarkets.
- Do not use other abrasive cleaners and/or wire wool ect., as it may scratch the ceramic glass surface of your cooktop.

### Damage from Sugary Spills and Melted Plastic

- Special care should be taken when removing hot substances **to avoid permanent damage of the glass surface**.
- Sugary spillovers (such as jellies, fudge, candy, syrups) or melted plastics can cause pitting of the surface of your cooktop (**not covered by the warranty**) unless the spill is removed while still hot. Special care should be taken when removing hot substances.

## Hints and Tips

| What?                                                                                                             | How?                                                                                                                                                                                                                                                                                                                                                                                                                                                                                                                             | Important!                                                                                                                                                                                                                                                                                                                                                                                                                                                                                  |
|-------------------------------------------------------------------------------------------------------------------|----------------------------------------------------------------------------------------------------------------------------------------------------------------------------------------------------------------------------------------------------------------------------------------------------------------------------------------------------------------------------------------------------------------------------------------------------------------------------------------------------------------------------------|---------------------------------------------------------------------------------------------------------------------------------------------------------------------------------------------------------------------------------------------------------------------------------------------------------------------------------------------------------------------------------------------------------------------------------------------------------------------------------------------|
| <p>Everyday soiling on glass (fingerprints, marks, stains left by food or non-sugary spillovers on the glass)</p> | <ol style="list-style-type: none"> <li>1. Switch off the power supply.</li> <li>2. Apply a vitro-ceramic glass cleaner while the glass is still warm (but not hot!)</li> <li>3. Rinse and wipe dry with a clean cloth or paper towel.</li> <li>4. Switch on the power supply to the cooktop.</li> </ol>                                                                                                                                                                                                                          | <ul style="list-style-type: none"> <li>• When turn off the power supply of cooktop, there will be no 'hot surface' indication but the cooking zone may still be hot! Take extreme care.</li> <li>• Heavy-duty scourers, some nylon scourers and harsh/abrasive cleaning agents may scratch the glass. Always read the label to check if your cleaner or scourer is suitable.</li> <li>• Never leave cleaning residue on the cooktop glass surface: the glass may become stained.</li> </ul> |
| <p>Boil over, melts, and hot sugary spills on the glass</p>                                                       | <p>Remove these immediately with a fish slice, palette knife or razor blade scraper suitable for ceramic glass of cooktop, but beware of hot cooking zone surfaces:</p> <ol style="list-style-type: none"> <li>1. Switch off the power supply.</li> <li>2. Hold the blade or utensil at a 30° angle and scrape the soiling or spill to a cool area of the cooktop.</li> <li>3. Clean the soiling or spill up with a dish cloth or paper towel.</li> <li>4. Follow steps 2 to 4 for 'Everyday soiling on glass' above.</li> </ol> | <ul style="list-style-type: none"> <li>• Remove stains left by melts and sugary food or spillovers as soon as possible. If left to cool on the glass, they may be difficult to remove or even permanently damage the glass surface.</li> <li>• Cut hazard: when the safety cover is retracted, the blade in a scraper is razor-sharp. Use with extreme care and always store safely and out of reach of children.</li> </ul>                                                                |
| <p>Spillovers on the touch controls</p>                                                                           | <ol style="list-style-type: none"> <li>1. Switch off the power supply.</li> <li>2. Soak up the spill</li> <li>3. Wipe the touch control area with a clean damp sponge or cloth.</li> <li>4. Wipe the area completely dry with a paper towel.</li> <li>5. Switch on the power supply to the cooktop.</li> </ol>                                                                                                                                                                                                                   | <ul style="list-style-type: none"> <li>• The cooktop may beep and turn itself off, and the touch controls may not function while there is liquid on them. Make sure you wipe the touch control area dry before turning the cooktop back on.</li> </ul>                                                                                                                                                                                                                                      |



## Maintenance of the cooktop

If you find something goes wrong for your cooktop, before contact the service or where you purchased it, please check whether below:

1. There is no power to the appliance:
  - Check whether there is a power cut of your department;
  - Check whether the appliance be connected to electricity properly;
  - Has the timer setting elapsed;
  - Whether it reaches the longest cooking time setting and auto shut off;
  - Whether there is liquid boiling over touch control panel and overflow protection devices auto shut off;
2. The touch control panel buttons can't be active:
  - Whether it's under "Child Lock", which there is "Lo" shows in timer displayer;
  - Whether liquid/wet cloth over touch control panel active overflow protection;
3. After cooking there is "H" shows on display:
  - This is normal. The cooktop is with Residual Heat Warning safety features. It will remain on until the surface is cool enough for touch.
4. After turn off, the fan of induction cooktop remains working for a while:
  - This is normal, this is to help appliances completely cool down.
5. Some pans make crackling or clicking noises during use of induction cooktop:
  - This is normal, it's the sound of induction coils during working, and for different construction of your cookware, the clicking might be slightly different.
6. The glass is being scratched:
  - Check whether you use unsuitable cookware, like rough-edged cookware.
  - Check whether unsuitable, abrasive scourer or cleaning products being used.

## Troubleshooting

If an abnormality comes up, the induction cooktop will enter the protective state automatically and display corresponding protective codes:

| Problem                                                                          | Possible causes                                                                                                                                                                                                                                                                                                                                                                                                                                            | What to do                                                                                                                                                                                                                                                                                                                                                                                                                                       |
|----------------------------------------------------------------------------------|------------------------------------------------------------------------------------------------------------------------------------------------------------------------------------------------------------------------------------------------------------------------------------------------------------------------------------------------------------------------------------------------------------------------------------------------------------|--------------------------------------------------------------------------------------------------------------------------------------------------------------------------------------------------------------------------------------------------------------------------------------------------------------------------------------------------------------------------------------------------------------------------------------------------|
| E1/E2                                                                            | Abnormal supply voltage                                                                                                                                                                                                                                                                                                                                                                                                                                    | Please check whether power supply is normal, Power on after the power supply is normal.                                                                                                                                                                                                                                                                                                                                                          |
| E3                                                                               | High temperature of the pan sensor                                                                                                                                                                                                                                                                                                                                                                                                                         | Check whether there is liquid in pan. Fill with liquid then restart.                                                                                                                                                                                                                                                                                                                                                                             |
| E5                                                                               | High temperature of the IGBT temperature sensor                                                                                                                                                                                                                                                                                                                                                                                                            | Please restart after the induction cooktop cools down.                                                                                                                                                                                                                                                                                                                                                                                           |
|  | <ol style="list-style-type: none"> <li>1. If a pan is too small for the induction burner, it can still be used. However, if the pan is a lot smaller than the burner, you may find that the induction hob won't activate when the pan is placed on the burner. This is simply because the pan is too small to register on the magnets.</li> <li>2. Wrong pot size used by the customer.</li> <li>3. Pot not appropriate for induction cooktops.</li> </ol> | <ol style="list-style-type: none"> <li>1. The cooking zones will not switch on if pots are not the right size. Only use pots bearing the symbol "INDUCTION SYSTEM"<br/></li> <li>2. Use a magnet to check if the bottom of the pot is suitable for the induction cooktop: bottom of the pots and pans are unsuitable if not magnetically detectable.</li> </ol> |

For all other error codes, switch off and call Customer Service.



## 電磁爐 使用說明

尊貴的用户：

感謝您使用惠而浦電磁爐，我們竭誠為您提供無憂服務，方便您的居家生活。請仔細閱讀本說明書，並妥善保管，以備日後查閱，維修。因公司產品不斷改進，如有更改，恕不另行通知。

### 目錄

|         |    |
|---------|----|
| 安全說明    | 24 |
| 安裝      | 26 |
| 操作說明    | 31 |
| 功率共享    | 34 |
| 爆炒功能    | 34 |
| 保溫功能    | 34 |
| 加速器功能   | 34 |
| 兒童鎖安全控制 | 35 |
| 暫停功能    | 35 |
| 使用定時器   | 36 |
| 鍋具檢測    | 36 |
| 餘熱警告    | 37 |
| 自動關機    | 37 |
| 過熱保護    | 37 |
| 防溢保護    | 37 |
| 烹調準則    | 37 |
| 烹飪技巧    | 37 |
| 保養與清潔   | 38 |
| 故障顯示與檢查 | 40 |

---

# 安全說明

---

## 必須閱讀和遵守的重要安全說明

在產品官網下載完整的說明手冊或撥打官網上的電話號碼。

在使用設備之前，請閱讀這些安全說明。將它們放在附近以備將來參考。這些說明和設備本身提供了重要的安全警告，請始終遵守。對於未能遵守這些安全說明、不當使用設備或不正確設置控制裝置，製造商不承擔任何責任。

**⚠ 警告：** 如果爐具表面破裂，請勿使用該設備 - 有觸電危險。

**⚠ 警告：** 火災危險：不要將物品存放在爐具表面上。

**⚠ 注意：** 烹飪過程必須受到監督。必須持續監督短暫的烹飪過程。

**⚠ 警告：** 在帶有脂肪或油的灶台上無人看管的烹飪可能是危險的 - 有火災危險。切勿繼  
陀用水滅火：而是關閉設備，然後蓋上火焰，例如：用蓋子或防火毯。

**⚠ 請勿將爐具用作工作檯面或支架。讓衣服或其他易燃材料遠離設備，直到所有組件完全冷  
。** - 有火災危險。

**⚠ 刀具、叉子、勺子和蓋子等金屬物體不應放在爐具表面，因為它們會變熱。**

**⚠ 非常年幼的兒童（0-3 歲）應遠離本產品。除非持續有人看管，否則幼兒（3-8 歲）應  
遠離設備。8歲及以上的兒童以及身體、感官或精神能力下降或缺乏經驗和知識的人只有在有  
人監督或獲得安全使用說明並了解所涉及的危險的情況下才能使用本設備。兒童不得玩弄本  
電器。兒童不得在沒有監督的情況下進行清潔和用戶維護。**

**⚠ 使用後，通過其控制關閉爐具元件，不要依賴鍋探測器。**

**⚠ 警告：** 設備及其可觸及部件在使用過程中會變熱。應注意避免接觸加熱元件。除非持續有  
人看管，否則 8 歲以下的兒童應遠離。

## 允許使用

**⚠ 注意：** 本設備不能通過外部開關設備（例如定時器）或單獨的遠程控制系統來操作。本設  
備旨在用於家庭和類似應用，例如：商店、辦公室和其他工作環境中的員工廚房區域；農  
舍；酒店、汽車旅館、住宿加早餐旅館和其他住宅環境中的客戶。

**⚠ 不允許其他用途（例如供暖室）。**

**⚠ 請勿在戶外使用本產品。**

## 安裝

**⚠ 設備必須由兩人或多人操作和安裝 - 有受傷風險。使用防護手套拆包和安裝 - 割傷  
風險。**



⚠ 安裝，包括供水（如果有）、電氣連接和維修必須由合格的技術人員進行。除非用戶手冊中特別說明，否則請勿修理或更換設備的任何部件。讓兒童遠離安裝地點。打開設備包裝後，請確保在運輸過程中沒有損壞。如果出現問題，請聯繫經銷商或離您最近的售後服務部。安裝後，包裝廢棄物（塑料、聚苯乙烯泡沫塑料部件等）必須存放在兒童接觸不到的地方 - 有窒息風險。在進行任何安裝操作之前，必須斷開設備與電源的連接 - 有電擊危險。在安裝過程中，確保設備不會損壞電源線 - 有火災或電擊危險。僅在安裝完成後激活設備。

⚠ 在安裝設備之前執行所有櫥櫃切割操作並清除所有木屑和鋸末。

⚠ 如果設備未安裝在烤箱上方，則必須在設備下方的隔間中安裝分隔板（不包含在產品配件內）。

## 電氣警告

⚠ 必須可以通過在插頭可觸及的情況下拔下設備或根據接線規則在插座上游安裝多極開關來斷開設備與電源的連接，並且設備必須按照國家電氣安全進行接地 標準。

⚠ 不要使用延長線、多個插座或適配器。安裝後用戶不得接觸電氣元件。請勿在濕身或赤腳時使用本產品。如果本設備的電源線或插頭損壞、不能正常工作、或已損壞或跌落，請勿操作本設備。

⚠ 如果電源線損壞，必須由製造商、其服務代理或具有類似資格的人員更換為相同的電源線，以避免危險 - 觸電風險。

## 保養與清理

⚠ **警告：** 在執行任何維護操作之前，請確保設備已關閉並斷開電源；切勿使用蒸汽清潔設備 - 觸電危險。

請勿使用研磨性或腐蝕性產品、含有氯基的清潔劑或鍋刷。

## 節能小貼士

在完成烹飪前幾分鐘將其關閉，以充分利用電爐的餘熱。鍋底應完全蓋住熱板；比熱板小的容器會導致能量浪費。

烹飪時用緊密的蓋子蓋住平底鍋和鍋具，並儘可能少用水。開蓋烹飪會大大增加能耗。

只能使用含有磁性的平底鍋和鍋具。

## 注意

使用心臟起搏器或類似醫療設備的人在此電磁爐打開時站在附近時應小心。電磁場可能會影響起搏器或類似設備。請諮詢您的醫生或心臟起搏器或類似醫療設備的製造商，了解有關其對電磁灶電磁場的影響的更多信息。

# 安裝

## 安裝說明

必須按照現行規定安裝和連接設備。

打開設備包裝後，確保沒有可見的損壞。如果在運輸過程中損壞，請勿使用，請立即聯繫您購買的地方。

## 安裝設備的選擇

根據圖紙所示尺寸切割工作檯面。

為了安裝和使用的目的，孔周圍應至少保留 5 cm 的空間。

確保工作表面的厚度至少為 30 mm。請選擇耐熱的工作檯面材料，以免因電磁爐加熱後高溫輻射造成較大的變形。如下所示：

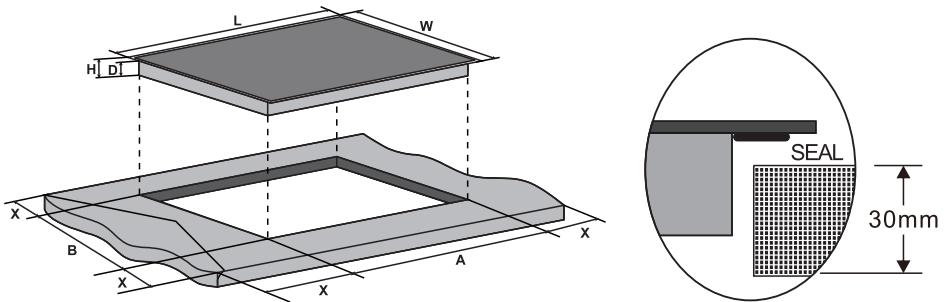

| 型號                       | L<br>(mm) | W<br>(mm) | H<br>(mm) | D<br>(mm) | A<br>(mm) | B<br>(mm) | X-min<br>(mm) |
|--------------------------|-----------|-----------|-----------|-----------|-----------|-----------|---------------|
| IWHL7320SC<br>IWHL7320SH | 730       | 430       | 60        | 54        | 660       | 390       | 50            |

在任何情況下，請確保電磁爐通風良好，進出風口不堵塞。確保電磁爐處於良好的工作狀態。如下所示：



注意：電磁爐與上方的櫥櫃之間的安全距離至少應為 760mm

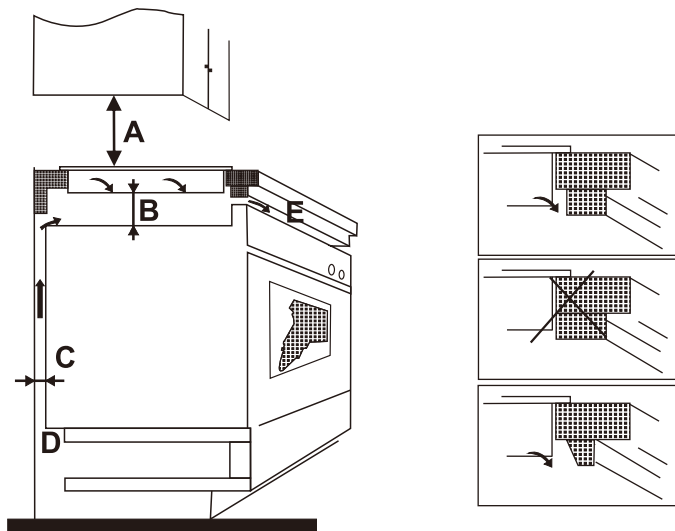

| A<br>(mm) | B<br>(mm) | C<br>(mm) | D2<br>(mm) | E<br>(mm) |
|-----------|-----------|-----------|------------|-----------|
| 最小 760    | 最小 50     | 最小 20     | 進風口最少 20   | 出風口最小 5   |

## 安裝海棉墊圈

在將爐灶面插入廚房檯面的開口之前，必須將隨附的海棉墊圈（塑料袋中）粘貼到陶瓷玻璃邊緣的下側。

**不要在沒有海棉墊圈的情況下安裝爐具！海棉墊圈應按以下方法連接到爐具上：**

- 去除墊圈上的保護膜。
- 然後將墊圈粘貼到玻璃的下側，靠近邊緣。
- 墊圈必須沿著玻璃邊緣的整個長度粘貼，並且不應在角落重疊。
- 安裝墊圈時，確保玻璃不接觸任何尖銳物體。

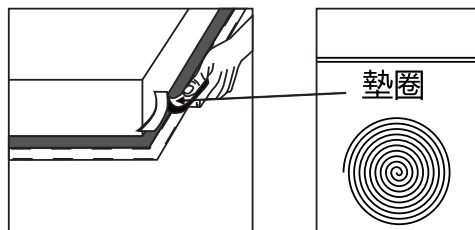

## 將爐具固定到櫥櫃

設備應放置在穩定、光滑的表面上（例如放置在產品包裝上）。請勿對從灶台突出的部分施力。

如下圖所示將爐灶面插入櫥櫃/工作檯面，以牢固地固定爐灶。

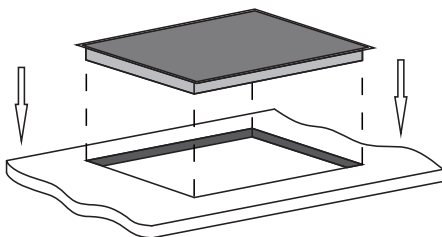

## 安裝可調節支架

- 安裝後，用螺絲固定在灶台底部的四個支架（見圖），將灶台固定在工作檯面上。
- 調整支架位置以適應不同工作檯面的厚度。

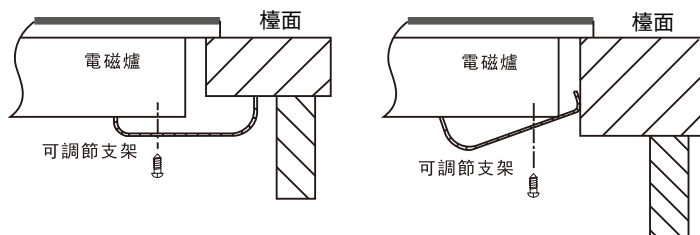

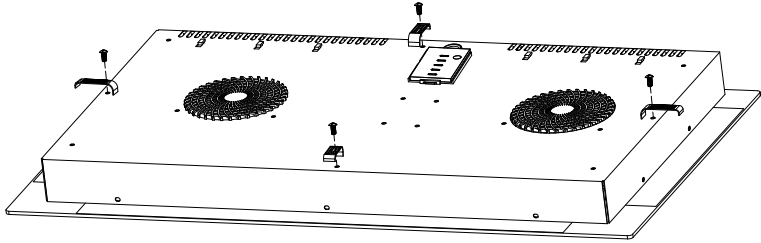

## 膠腳

IWHL7320SC 標配4個膠腳。

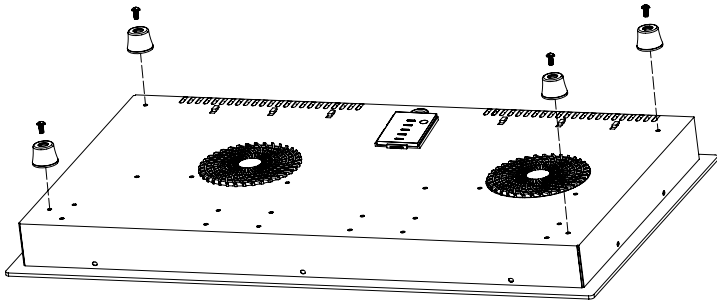

## 將爐具連接到主電源

電源應連接符合相關標準，或單極斷路器。

該設備具有較大的額定功率，必須由合格的電工連接電源。

### 注意：

1. 如果電纜損壞或需要更換，應由售後技術人員使用適當的工具進行，以免發生意外。
2. 如果設備直接連接到電源，則必須安裝一個全極斷路器，觸點之間的最小間隙為 3mm。
3. 安裝人員必須確保進行了正確的電氣連接並且符合安全規定。
4. 電纜不得彎曲或壓縮。
5. 電纜必須定期檢查，並且只能由合格的技術人員更換。

## 注意事項

1. 爐具必須由合格人員或技術人員安裝。請勿自行操作。
2. 電爐灶不得安裝在冷卻設備、洗碗機和旋轉式烘乾機上。
3. 電磁爐的安裝要保證更好的散熱，提高可靠性。
4. 工作面以上的牆壁和感應加熱區應能耐熱。
5. 為避免損壞，夾層和粘合劑必須是耐熱的。
6. 不得使用蒸汽清潔器。

**注意：**IWHL7320SC 電源線帶有插頭。您可以直接將其插入插座使用，使用後請保持電源線插頭拔出。

IWHH7320SH 的電源線不帶插頭，連接方法如下所示。

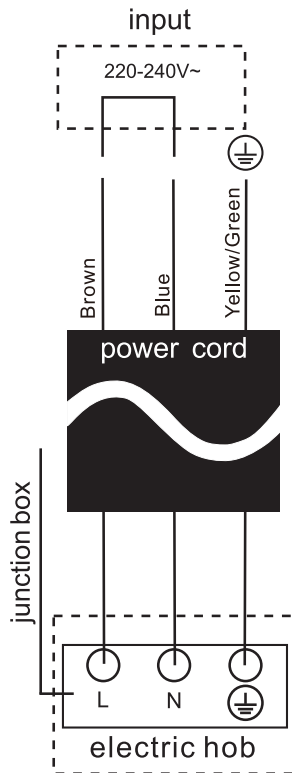

# 操作說明

型號: IWHL7320SC, IWHH7320SH

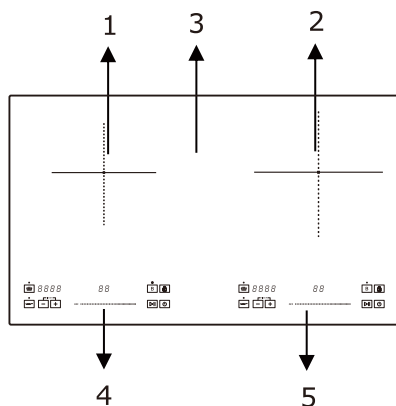

1. 2200W 最大 2800W 烹飪區
2. 2200W 最大 2800W 烹飪區
3. 陶瓷玻璃面板
4. 控制面板#1
5. 控制面板#2

## 控制面板

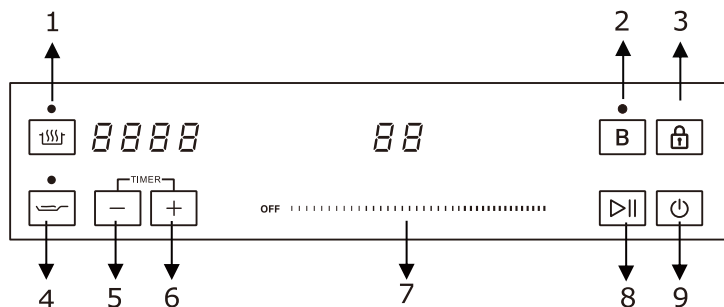

1. 保溫控制按鈕
2. 火力加速鍵
3. 兒童安全鎖
4. 爆炒控制按鈕
- 5/6. 定時器控制鍵
7. 火力控制感應鈕
8. 暫停控制按鈕
9. 電源開關

注意：手冊中的產品圖僅供參考，由於本公司產品不斷精益求精，因此規格與設計若有變動時，請恕本公司不另行通知。

## 使用新電磁爐之前

- 閱讀本指南，特別注意“安全警告”部分。
- 去除新電磁爐上可能仍存在的任何保護膜。

## 使用觸控控制

- 按鍵對觸摸做出響應，因此您無需施加任何壓力。
- 使用指肚，而不是指尖。
- 每次有效觸摸時，您都會聽到嗶聲。
- 確保控制面板始終清潔、乾燥，並且沒有物體（例如器具或布）覆蓋它們。即使是一層薄薄的水膜也可能使控制裝置難以操作。

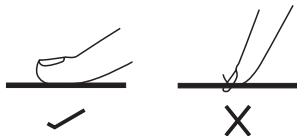

## 選擇合適的鍋具



- 僅使用底部適合的鍋具感應烹飪。尋找包裝上或底部有感應符號的鍋。

- 您可以通過以下方式進行磁鐵測試，檢查您的鍋具是否合適。將磁鐵移向鍋底，如果被吸引則鍋具適合用於電磁爐。
- 如果您沒有磁鐵：

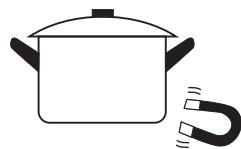

1. 在你要檢查的鍋裡放一些水。

2. 如果顯示屏不閃爍  且水正在被加熱，則表示鍋具合適。

- 由以下材料製成的鍋具不適用於電磁爐：純不銹鋼、沒有磁性底座的鋁或銅、玻璃、木材、瓷器、陶瓷和陶器。
- 電磁爐由光滑的陶瓷玻璃製成，熱量來自磁感應線圈，它加熱鍋具而不是爐具表面。鍋具的熱量傳遞給食物。
- 請務必僅使用專門設計和/或批准用於電磁爐的金屬鍋。切勿讓三聚氰胺或塑料容器接觸加熱區。
- 電磁爐可能無法檢測到直徑小於 140 毫米的鍋具。
- 不要使用邊緣呈鋸齒狀或底部彎曲的鍋具。



確保鍋具底部光滑，平放在玻璃上，並且與烹飪區大小相同。如果您使用較小的鍋，效率可能會低於預期。始終將鍋具放在烹飪區的中心。

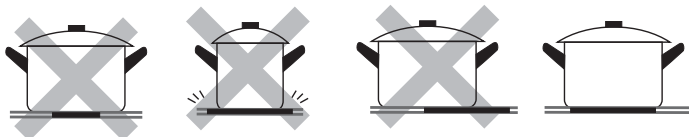





## 功率共享

您的電磁爐有功率共享功能，此功能將總功率限制在 4400W (IWHH7320SH) 和 2800W (IWHL7320SC) 以內。當 2 個烹飪區一起工作且總功率達到 4400W/2800W 時，如果您想增加一個烹飪區的功率，程序將自動調節/關閉另一個烹飪區的功率，以使總功率保持在此限定範圍內。

## 使用爆炒功能

IWHL7320SC, IWHH7320SH 具有爆炒功能，可以將烹飪區切換到最高溫度檔位，以減少烹飪時間。

要在爐子工作時開啟爆炒功能，請按以下步驟操作：

1. 直接觸摸您要使用的烹飪區的炒功能  按鈕。

**注意：**

1. 通過單觸式爆炒功能按鈕，爐具以最高溫度檔位 260°C 工作。
2. 爆炒功能啟動時，爆炒功能指示燈亮。
3. 通過再次觸摸熱炒按鈕，將退出熱炒功能。

## 使用保溫功能

IWHL7320SC, IWHH7320SH 帶有保溫功能，讓食物在一段時間內保持在所需溫度非常方便。

要在爐具工作時激活保溫功能，請執行以下操作：

1. 點擊您要使用的烹飪區的保溫功能按鈕 .
2. 默認溫度設置為 45°C，同時可以按保溫再次按功能鍵從 45, 65, 85°C 循環調節取決於你想要的溫度。

**注意：**

1. 在保溫功能中，爐具在默認溫度 45°C 下工作。
2. 保溫功能開啟時，保溫功能指示燈亮。
3. 長按保溫控制按鈕，烹飪區工作在以下後果：

-烹飪區：“45°C-65°C-85°C-取消-45°C-65°C-85-取消……”

**取消保溫功能**

1. 再次觸摸保溫控制按鈕，直到取消保溫功能，然後烹飪區將恢復其原始功率設置。
2. 您必須先取消保溫功能，然後才能切換到熱炒或加速器功能。

## 使用加速器功能

IWHL7320SC, IWHH7320SH 有兩個具有助推器功能的烹飪區。您可以使用“加速器”功能來提高相關烹飪區的功率，最大功率輸出持續 5 分鐘。此功能可以減少烹飪時間，方便趕時間的烹飪！

要在爐子工作時使用助推器功能，請執行以下操作：

1. 激活您要使用助推器功能的烹飪區。
2. 輕觸加速器功能控制按鈕  [B]，加熱防區指示燈將顯示“b”並閃爍 5 秒

然後停止閃爍，然後激活助推器功能。

**注意：** 1. 加速器完成後，烹飪區將恢復原始設置。

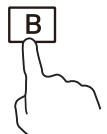

## 取消加速器功能

- 加速器工作時，再按照上述激活加速器功能的做法一次，可以取消加速器功能。
- 您還可以通過調整功率級別設置來取消加速器功能。

## 兒童鎖安全控制

- 您可以通過激活童鎖功能鎖定控制面板以防止意外使用（例如兒童意外打開烹飪區）。
- 當控制面板被鎖定時，除開/關按鈕和童鎖按鈕外，所有其他觸摸控制按鈕都被禁用。



### 鎖定控制面板

輕觸童鎖控制按鈕  一次。定時器指示燈將顯示“Lo”，童鎖功能啟動。

### 解鎖控制面板

1. 確保電磁爐已打開。
2. 長按童鎖控制鍵約  3秒，蜂鳴器響一聲，定時器指示燈“Lo”消失，童鎖解除。
3. 您現在可以開始使用您的電磁爐了。



在童鎖模式下，除開/關按鈕  和童鎖按鈕  外，所有控制按鈕均無效。

在緊急情況下，您可以隨時使用開/關  控制關閉爐具，但您應在下次操作時先解鎖爐具。

**注意：**在童鎖功能下，如果在未激活童鎖功能的情況下關閉爐具。稍後打開爐具時，童鎖功能仍然有效，須先解鎖控制面板，否則無法開機。

## 暫停功能

- 讓烹飪變得簡單！做飯時，你的門鈴響了，電話響了，或者從另一扇門傳來孩子的叫喊聲。需要走出廚房？這意味著晚餐可能會被燒焦，或者如果您關閉所有設備，則需要更長的時間才能準備好。
- 暫停功能可以關閉所有區域。當您返回時，再按一次  按鈕，爐具將重新啟動，繼續烹飪。

### 1. 激活暫停功能

要激活暫停功能，您可以按一下暫停功能按鈕。然後保持所有程序設置，灶台停止加熱，所有加熱設置指示燈顯示“P”。

### 2. 退出暫停功能

 要取消暫停功能，您可以在返回後再次按下暫停功能。然後所有的程序設置將恢復到原來的狀態，暫停指示燈“P”從所有LED中消失。當激活暫停功能時，所有控制按鈕都被禁用，除了開/關、童鎖和暫停按鈕。

注意：如果暫停功能持續超過 10 分鐘，爐具將自動關閉。



## 餘熱警告

### 小心高溫表面

爐具運行一段時間後，會有一些餘熱。計時器顯示 LED 中出現字母 “H” 以警告您遠離它。

### 它也可以用作節能功能：

如果您想進一步加熱鍋具，請使用仍然很熱的玻璃板。



## 自動關機

爐具的另一個安全功能是自動關機。當您忘記關閉烹飪區時，就會出現這種情況。默認關機時間（小時）如下表：

|        |   |   |   |   |   |   |   |   |   |    |    |    |
|--------|---|---|---|---|---|---|---|---|---|----|----|----|
| 火力等級   | 1 | 2 | 3 | 4 | 5 | 6 | 7 | 8 | 9 | 10 | 11 | 12 |
| 默認工作時長 | 8 | 8 | 8 | 8 | 4 | 4 | 4 | 4 | 2 | 2  | 2  | 2  |

## 過熱保護

配備的溫度傳感器可以監測爐具內的溫度。當監測到溫度過高時，爐具將自動停止運行。

## 防溢保護

為了您的安全，如果觸摸控制面板上有液體或濕布，程序將自動關閉電源。除開/關和童鎖按鈕外，所有控制按鈕均無效，除非您將觸摸控制區域擦乾。

## 烹調準則

油炸時要小心，因為油和脂肪會迅速升溫，尤其是在使用 Booster 功能時。在極高的溫度下，油脂會自燃，這存在著火的危險。

## 烹飪技巧

- 當食物開始沸騰時，請將火力設定值調小。
- 蓋上鍋蓋可以減少烹調時間，並且確保溫度以節約能源。
- 盡量減少液體或脂肪的量，以減少烹飪時間。
- 開始烹調時先設定在高火力，然後在食物熱透之後降低火力。

## 慢燉、煮飯

1. 燉煮溫度約 85° C、液體邊緣會開始冒出泡泡。利用低於沸點的溫度設定，可以讓湯或慢燉時的食材風味更為濃郁也可避免過度烹煮。您也可以利用這樣的溫度設定來烹煮蛋類料理及收乾醬汁。
2. 如悶煮米飯之類的烹調方式，需先設定較高的加熱段數再調低，以確保食物可在建議時間內適當烹煮完成

## 煎煮牛排

要煎煮出多汁的牛排時：

1. 烹調前將肉在室溫下靜置約 20 分鐘。
2. 加熱鍋具。
3. 在牛排兩面刷上油。在熱鍋中滴少量油，然後將肉放在熱鍋上。
4. 在烹飪過程中只轉動牛排一次。確切的烹飪時間取決於牛排的厚度和你想要的烹飪方式。時間可能從每邊大約 2 到 8 分鐘不等。按下牛排來衡量它的煮熟程度——感覺越硬，它就會越“做得好”。
5. 將牛排放在溫暖的盤子上靜置幾分鐘，讓它在上菜前放鬆並變軟。

## 熱炒

1. 請選擇適用於電磁爐的鍋具或大型煎鍋
2. 熱炒多為高溫快炒，請先將所有所有配料和設備準備好。若食材份量較多，請以少量多次進行烹調。
3. 請先預熱鍋具並加入兩湯匙的油。
4. 請先烹煮肉類並靜置保溫。
5. 當青菜炒熟但仍清脆的程度時，將火力調低，再將炒過的肉倒翻炒並調味。
6. 輕輕拌炒食材以確保食物完全加熱
7. 請馬上享用

---

## 保養與清潔

---

**重要提示：**在進行任何保養或清潔工作之前，請斷開設備與電源的連接，並確保設備完全冷卻。

### 清潔爐具表面

使用後應儘快清除灶台表面的溢出物。清潔前務必確保表面足夠冷卻。

使用軟布或廚房紙清潔表面。如果溢出物已在表面乾燥，您可能需要使用專業的陶瓷玻璃清潔劑，大多數超市都有售。

請勿使用其他研磨清潔劑和/或鋼絲絨等，因為它可能會劃傷爐具的陶瓷玻璃表面。

### 含糖溢出物和熔化塑料造成的損害

去除熱物質時應特別小心，以免對玻璃表面造成永久性損壞。

含糖溢出物（如果凍、軟糖、糖果、糖漿）或熔化的塑料可能會導致爐具表面出現凹坑（不在保修範圍內），除非溢出物在仍然很熱時被清除。

## 提示和小技巧

| 清潔項目                               | 步驟                                                                                                                                                                                                                           | 注意                                                                                                                                                                                                       |
|------------------------------------|------------------------------------------------------------------------------------------------------------------------------------------------------------------------------------------------------------------------------|----------------------------------------------------------------------------------------------------------------------------------------------------------------------------------------------------------|
| 玻璃上的日常污漬(玻璃面上的指紋、汗漬、食物殘渣及不含糖分的污漬等) | <ol style="list-style-type: none"> <li>1. 關上電源。</li> <li>2. 於玻璃爐面尚有餘溫(非高溫)時使用爐面清潔劑清理</li> <li>3. 用乾淨的布或紙巾洗淨並擦乾。</li> <li>4. 重新啟動電源。</li> </ol>                                                                               | <ul style="list-style-type: none"> <li>● 當電磁爐電源關掉時，「高溫爐面」的顯示也會熄滅，但是烹調區可能還是很燙！請特別小心。</li> <li>● 強效菜瓜布、某些尼龍菜瓜布以及腐蝕性清潔劑可能刮傷玻璃面。一定要閱讀標籤說明以確認您的清潔用品是否適合。</li> <li>● 切勿將清潔劑殘留餘爐具玻璃表面，以免玻璃表面會留下污漬痕跡。</li> </ul> |
| 清除玻璃表面上的外溢或融化殘渣及含糖份的污漬等            | <p>請立即用鍋鏟或者電磁爐玻璃適用的刮刀將這些汗漬去除，但請注意烹調區表面的高溫：</p> <ol style="list-style-type: none"> <li>1. 關掉電磁爐牆上的電源。</li> <li>2. 將刮刀或其他工具保持30°角，將汗漬物刮除並移到較涼處。</li> <li>3. 用抹布或廚房紙巾將刮下來的汗漬拭除。</li> <li>4. 依照上述「清除玻璃上日常汗漬」的步驟2到4清理。</li> </ol> | <ul style="list-style-type: none"> <li>● 食物融化殘渣和含糖份的污漬應盡快清理。如果這些汗漬留在玻璃面上冷卻後會很難清理，甚至會造成玻璃永久損傷。</li> <li>● 割傷危險：刮刀的刀鋒很鋒利，當刮刀安全拿起時，請留意刀鋒以免割傷。使用時也請特別注意，也請務必將刮刀存放於孩童無法拿取的位置。</li> </ul>                      |
| 清除觸控按鈕上的外溢殘渣、或融化殘渣                 | <ol style="list-style-type: none"> <li>1. 關掉電磁爐的電源。</li> <li>2. 將汗漬弄濕軟化。</li> <li>3. 用乾淨的海綿或抹布沾水擦拭觸碰控制區。</li> <li>4. 用廚房紙巾將此區域完全擦乾。</li> <li>5. 將電磁爐的電源打開。</li> </ol>                                                        | <ul style="list-style-type: none"> <li>● 當觸碰感應區有水時，爐具可能會發出嗶聲並自動關閉，且觸控感應區將可能無法運作。請先確認觸碰面板區域已擦乾再重新啟動爐具。</li> </ul>                                                                                         |

## 保養

如果您發現您的爐具出現問題，請在聯繫服務人員或購買地點之前檢查以下是否：

1. 電器沒電：

- 檢查您所在部門是否停電；
- 檢查電器是否正確連接電源；
- 定時器設置是否已過；
- 是否達到最長烹飪時間設置並自動關閉；
- 觸摸控制面板是否有液體沸騰和溢出保護裝置自動關閉；



2. 觸摸面板按鍵無法激活：

- 是否在“兒童鎖”下，定時器顯示有“Lo”；

- 觸摸控制面板上的液體/濕布是否主動溢出保護；
3. 煮好後顯示“H”：
    - 這個是正常的。爐具有餘熱警示功能。它會一直閃爍，直到表面冷卻到可以觸摸為止。
  4. 關閉後，電磁爐風扇繼續工作一段時間：
    - 這是正常的，這是為了幫助電器完全冷卻。
  5. 有的鍋具在使用電磁爐時會發出劈啪聲或咔嚓聲：
    - 這是正常的，是感應線圈工作時發出的聲音，不同的鍋具結構，咔嚓聲可能會略有不同。
  6. 玻璃被劃傷：
    - 檢查您是否使用了不合適的鍋具，例如邊緣粗糙的鍋具。
    - 檢查是否使用了不合適的磨料擦洗器或清潔產品。

## 故障顯示與檢查

如果出現異常，電磁爐會自動進入保護狀態，並顯示相應的保護代碼：

| 問題                                                                               | 可能原因                                                                                                                                                                              | 解決辦法                                                                                                                                                                                                                                 |
|----------------------------------------------------------------------------------|-----------------------------------------------------------------------------------------------------------------------------------------------------------------------------------|--------------------------------------------------------------------------------------------------------------------------------------------------------------------------------------------------------------------------------------|
| E1/E2                                                                            | 供電電壓異常                                                                                                                                                                            | 請檢查供電是否正常。<br>確認供電正常之後請將再開機。                                                                                                                                                                                                         |
| E3                                                                               | 陶瓷玻璃板溫度過高                                                                                                                                                                         | 請檢查鍋具是否無水，請裝水後重新開機。                                                                                                                                                                                                                  |
| E5                                                                               | IGBT 溫度傳感器高溫                                                                                                                                                                      | 請在電磁爐溫度降低之後重新開機。                                                                                                                                                                                                                     |
|  | <ol style="list-style-type: none"> <li>1. 如果電磁爐的鍋較小，仍然可以使用。但是，如果鍋具底部比烹飪區小很多，您可能會發現將鍋具放在烹調區上時電磁爐不會啟動。這是因為鍋具底部尺寸太小而無法被識別。</li> <li>2. 客戶使用的鍋尺寸錯誤。</li> <li>3. 鍋具不適用於電磁爐。</li> </ol> | <ol style="list-style-type: none"> <li>1. 如果鍋的大小不合適，烹飪區將不會啟動。<br/>只可使用帶有“電磁爐適用”標識的鍋具<br/></li> <li>2. 使用磁鐵檢查鍋底是否適合電磁爐：如果鍋底不能被磁性吸附，則不適合。</li> </ol> |

關於所有其他錯誤代碼，請關閉並致電您的服務提供商。



## REGISTER YOUR PRODUCT ONLINE

---

For Hong Kong Market



Scan QR Code or visit  
**[www.whirlpool.com.hk](http://www.whirlpool.com.hk)**  
to register your product warranty online.

This QR Code is only applicable to Hong Kong.  
You can download the user manual by

- Visiting our website **[www.whirlpool.com.hk](http://www.whirlpool.com.hk)**
- Contracting our Customer Service Center at (852) 2406 9138

For Singapore Market



Scan QR Code or visit  
**[www.whirlpool.com.sg/warranty-registration](http://www.whirlpool.com.sg/warranty-registration)**  
to register your product warranty online.

This QR Code is only applicable to Singapore.  
You can download the user manual by

- Visiting our website **[www.whirlpool.com.sg](http://www.whirlpool.com.sg)**
- Contacting our Customer Service Hotline at (65) 6250 6888 or email **[helpdesk.sg@whirlpool.com](mailto:helpdesk.sg@whirlpool.com)**

---

Whirlpool® Registered trademark/TM Trademark of Whirlpool group of companies

All rights reserved - <http://www.whirlpool.com.hk>  
- <http://www.whirlpool.com.sg>

註冊商標/惠而浦集團的TM商標

版權所有 翻印必究 - <http://www.whirlpool.com.hk>  
- <http://www.whirlpool.com.sg>

