

Whirlpool

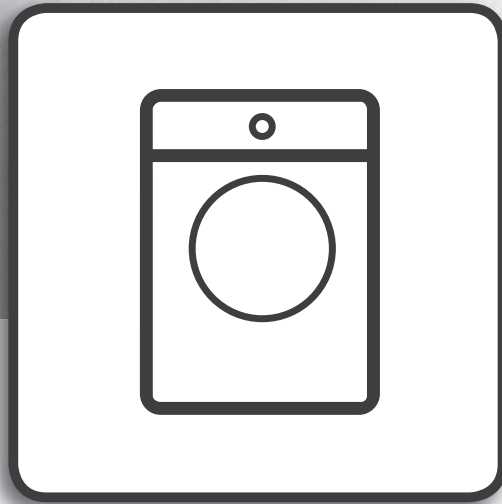

Health & Safety, Use & Care, Installation Guide and Online Warranty Registration Information

產品安全指引、使用說明、安裝指南及
網上登記保養資料

Model 產品型號 : HWMB9002GW



www.whirlpool.com.hk
www.whirlpool.com.sg

ENGLISH 3

繁體中文 11

USER MANUAL



THANK YOU FOR BUYING A WHIRLPOOL PRODUCT.

In order to receive a more complete assistance,
please register your appliance on www.whirlpool.com.hk
www.whirlpool.com.sg

INDEX

USER MANUAL	3
INSTALLATION GUIDE	4
SAFETY INSTRUCTIONS	5
CONTROL PANEL	7
INDICATORS	7
FIRST TIME USE	7
DAILY USE	7
OPENING THE DOOR DURING THE CYCLE	7
NAVIGATION	7
SETTINGS	7
CARE LABEL	7
PROGRAMS	8
OPTIONS	8
CARE AND MAINTENANCE	9
TRANSPORT AND HANDLING	9
PRODUCT DESCRIPTION	9
TROUBLESHOOTING	10
CHINESE PROGRAM LABEL PLACEMENT	19

INSTALLATION GUIDE

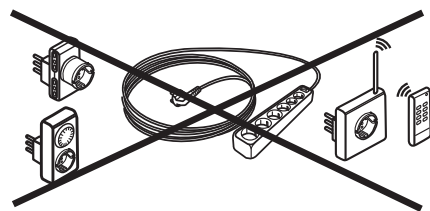
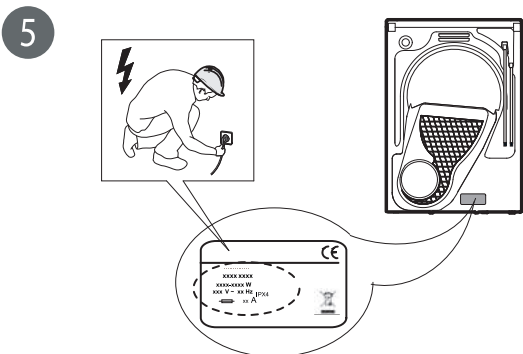
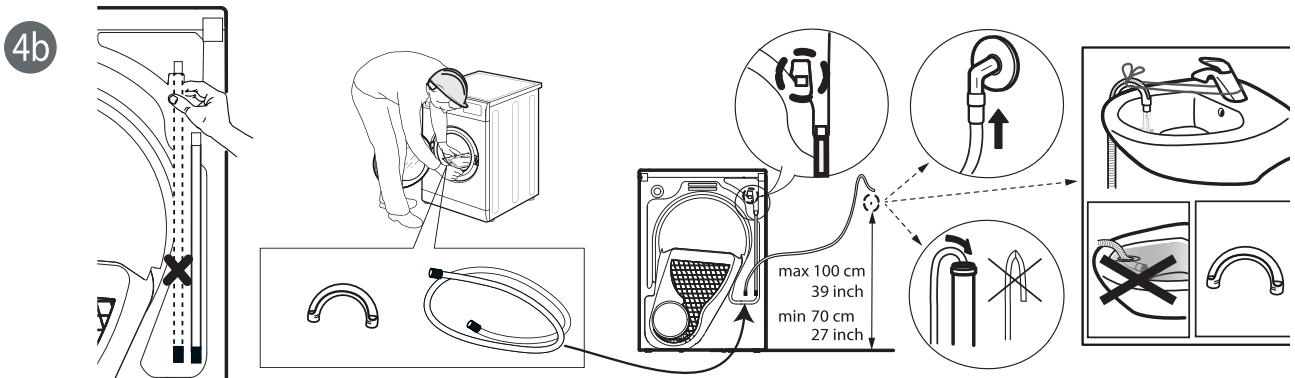
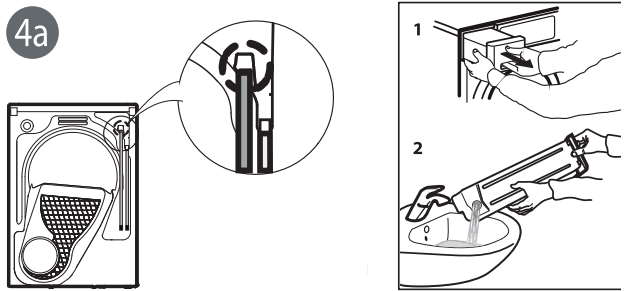
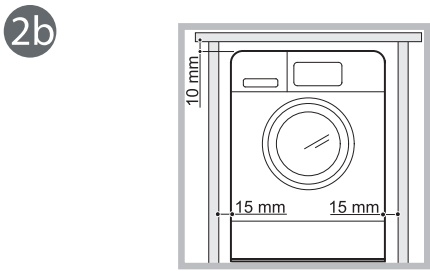
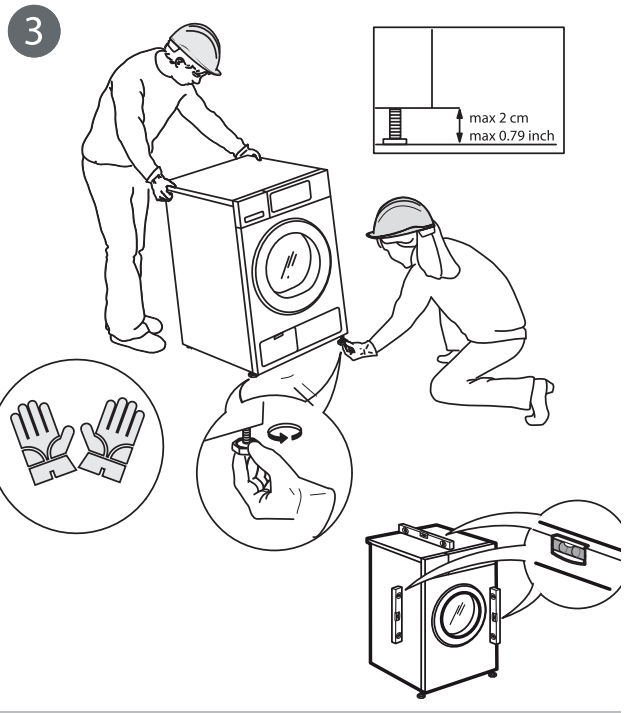
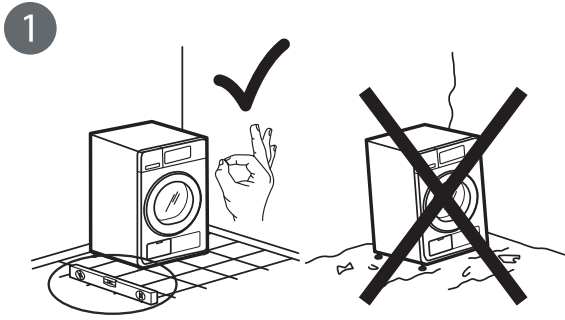



SAFETY INSTRUCTIONS

IMPORTANT TO BE READ AND OBSERVED

 This symbol reminds you to read this instruction manual. Before using the appliance, read these safety instructions. Keep them nearby for future reference. These instructions and the appliance itself provide important safety warnings, to be observed at all times. The manufacturer declines any liability for failure to observe these safety instructions, for inappropriate use of the appliance or incorrect setting of controls.

 Very young children (0-3 years) should be kept away from the appliance. Young children (3-8 years) should be kept away from the appliance unless continuously supervised. Children from 8 years old and above and persons with reduced physical, sensory or mental capabilities or lack of experience and knowledge can use this appliance only if they are supervised or have been given instructions on safe use and understand the hazards involved. Children must not play with the appliance. Cleaning and user maintenance must not be carried out by children without supervision.

 **WARNING:** Never stop a tumble dryer before the end of the drying cycle unless all items are quickly removed and spread out so that the heat is dissipated.

 Items that have been soiled with substances such as cooking oil, acetone, alcohol, petrol, kerosene, spot removers, turpentine, waxes and wax removers and items such as foam rubber (latex foam), shower caps, waterproof textiles, rubber-backed articles and clothes or pillows fitted with foam rubber pads should not be dried in the tumble dryer. Remove all objects from pockets, such as lighters and matches. Do not use the tumble dryer if industrial chemicals have been used to clean it.

 Oil-soaked items should not be dried in the tumble dryer due to their high flammability.

 Never open the door forcibly or use it as a step.

PERMITTED USE

 **CAUTION:** The appliance is not intended to be operated by means of an external switching device, such as a timer, or separate remote controlled system.

 This appliance is intended to be used in household and similar applications such as: staff kitchen areas in shops, offices and other working environments; farm houses; by clients in hotels, motels, bed & breakfast and other residential environments.

 This appliance is not for professional use. Do not use the appliance outdoors.

 Do not store explosive or flammable substances (e.g. gasoline or aerosol cans) inside or near the appliance - risk of fire.

 Do not load the machine above the maximum capacity (kg of dry cloth) indicated in the programme table.

 Do not dry unwashed items in the tumble dryer.

 Take care that no lint or dust has accumulated around the dryer.

 Fabric softeners, or similar products, should be used as specified by the fabric softener instructions.

 Do not overdry the laundry.

INSTALLATION

 The appliance must be handled and installed by two or more persons - risk of injury. Use protective gloves to unpack and install - risk of cuts.

 Installation, including water supply (if any), electrical connections and repairs must be carried out by a qualified technician. Do not repair or replace any part of the appliance unless specifically stated in the user manual. Keep children away from the installation site. After unpacking the appliance, make sure that it has not been damaged during transport. In the event of problems, contact the dealer or your nearest After-sales Service. Once installed, packaging waste (plastic, styrofoam parts etc.) must be stored out of reach of children - risk of suffocation. The appliance must be disconnected from the power supply before any installation operation - risk of electric shock. During installation, make sure the appliance does not damage the power cable - risk of fire or electric shock. Only activate the appliance when the installation has been completed.

 Install the dryer in rooms with adequate ventilation (open door, ventilation grid or slot larger than 500 cm²) in order to avoid the backflow of gases into the room from appliances burning other fuels, including open fires. If the dryer is installed under a worktop, provide a distance of 10 mm between the upper panel of the dryer and any objects above it, and 15 mm between the sides of the appliance and the walls or furniture units adjacent to it.

 If the dryer is installed near to a gas or coal stove, provide a heat insulating plate (85 cm x 57 cm) in between, as the side facing the stove is covered with aluminium foil.

 Exhaust air must not be discharged into a flue which is used for discharging fumes from appliances burning gas or other fuels.

 The appliance must not be installed behind a lockable door, a sliding door or a door with a hinge on the opposite side to that of the tumble dryer, in such a way that a full opening of the tumble dryer door is restricted.

 The appliance shall be placed against the wall to limit access to its rear side.

 Take care not to use a carpet which obstructs ventilation openings in the base of the dryer.

 If you want to stack the dryer on a washing machine, first contact our After-Sales Service or your specialist dealer to verify the complete list of suitable models. The stacking is only possible if the dryer is attached to the washing machine by means of the appropriate stacking kit available through our After-Sales Service or your specialist dealer. Instructions for the correct assembly are supplied with the stacking kit.

SAFETY INSTRUCTIONS

ELECTRICAL WARNINGS

 It must be possible to disconnect the appliance from the power supply by unplugging it if plug is accessible, or by a multi-pole switch installed upstream of the socket in accordance with the wiring rules and the appliance must be earthed in conformity with national electrical safety standards.

 Do not use extension leads, multiple sockets or adapters. The electrical components must not be accessible to the user after installation. Do not use the appliance when you are wet or barefoot. Do not operate this appliance if it has a damaged power cable or plug, if it is not working properly, or if it has been damaged or dropped.

 If the supply cord is damaged, it must be replaced with an identical one by the manufacturer, its service agent or similarly qualified persons in order to avoid a hazard - risk of electric shock.

CLEANING AND MAINTENANCE

 **WARNING:** Ensure that the appliance is switched off and disconnected from the power supply before performing any maintenance operation. To avoid risk of personal injury use protective gloves (risk of laceration) and safety shoes (risk of contusion); be sure to handle by two persons (reduce load); never use steam cleaning equipment (risk of electric shock).

Non-professional repairs not authorized by the manufacturer could result in a risk to health and safety, for which the manufacturer cannot be held liable. Any defect or damage caused from non-professional repairs or maintenance will not be covered by the guarantee, the terms of which are outlined in the document delivered with the unit.

 Make sure that all lint traps are cleaned before starting any drying cycle.

DISPOSAL OF PACKAGING MATERIALS

The packaging material is 100% recyclable and is marked with the recycle symbol .

The various parts of the packaging must therefore be disposed of responsibly and in full compliance with local authority regulations governing waste disposal.

DISPOSAL OF HOUSEHOLD APPLIANCES

This appliance is manufactured with recyclable or reusable materials. Dispose of it in accordance with local waste disposal regulations. For further information on the treatment, recovery and recycling of household electrical appliances, contact your local authority, the collection service for household waste or the store where you purchased the appliance. This appliance is marked in compliance with European Directive 2012/19/EU, Waste Electrical and Electronic Equipment (WEEE) and with the Waste Electrical and Electronic Equipment regulations 2013 (as amended). By ensuring this product is disposed of correctly, you will help prevent negative consequences for the environment and human health.

The  symbol on the product or on the accompanying documentation indicates that it should not be treated as domestic waste but must be taken to an appropriate collection center for the recycling of electrical and electronic equipment.

THANK YOU FOR BUYING A WHIRLPOOL PRODUCT.

In order to receive a more complete assistance, please register your product on www.whirlpool.com.hk / www.whirlpool.com.sg



Before using the appliance carefully read the Safety Instructions.

CONTROL PANEL

- 1 Programme selection knob
- 2 On/Off button
- 3 Start/Pause button

Options buttons

- 4 FreshCare+
- 5 Cycle End Signal
- 6 Rapid
- 7 Cycle Options (hold for Settings)
- 8 Dryness Level
- 9 Timed Drying
- 10 Start Delay

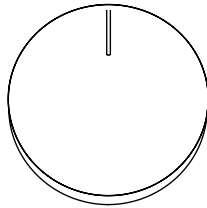

1

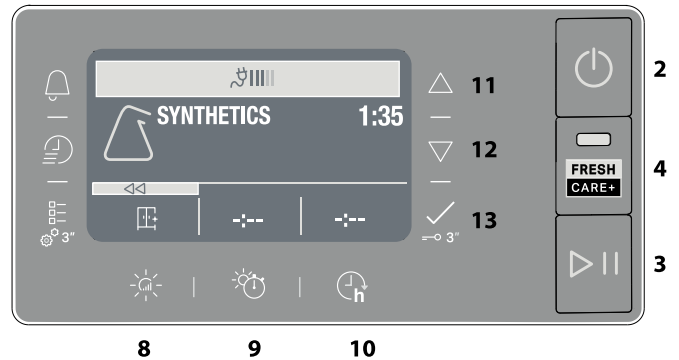
**Navigation buttons and Key Lock**

- 11 UP
- 12 DOWN
- 13 CONFIRM (hold for Key Lock)

INDICATORS

Cycle phase: ☀ Drying - 🌬 Cool Down - ⌚ End of Cycle

🚰 Empty water tank - 🧼 Clean secondary filter - 🚰 Clogged door filters - 🧼 Autoclean - 🌱 Eco Monitor

Refer to Troubleshooting section: 🛠 Failure call After-sales Service - DEMO Demo Mode

FIRST TIME USE

When starting the appliance the first time, the control panel will automatically show the set language menu. The **UP** and **DOWN** buttons are used to show the languages available in the machine. Press the button to confirm. The machine cannot be used without having selected the language.

Make sure that the water tank is correctly inserted.

The dryer must be installed in a room with a temperature ranging between 5°C and 35°C to ensure proper operation. Before using the dryer make sure it has been in an upright position for at least 6 hours.

Should you wish to change the opening side of the door, please contact our After-sales Service. (See phone number in the warranty booklet).

DAILY USE

Doing this will keep your machine working at its BEST:
 - remember to empty your water tank after each drying cycle.
 - remember to clean your filters after each drying cycle.

Refer to the Care & Maintenance section.

1. Plug the dryer into the power supply socket.
2. Open the door and load garments; always refer to instructions on clothing labels and the max loads indicated in the programme section. Empty pockets. Make sure garments do not get caught between the door and/or the door filter. Do not load items that are dripping wet. Do not tumble dry large, very bulky items.
3. Close the door.
4. Press the "On/Off" button.
5. Select the most suitable programme for the type of fabric in that load.
6. Select the options, if necessary.
7. Press the "Start/Pause" button to begin drying.
8. At the end of the drying cycle, a buzzer will beep. An indicator on the control panel signals the end of the cycle. Pull the load out immediately to prevent the formation of creases on laundry.
9. Turn the machine off by pressing the "On/Off" button, open the door and pull the clothing out. If the machine is not switched off manually, after about a quarter of an hour from the end of the cycle, the appliance turns off automatically to save energy. Note that some programme/option accords with "Crease Care" system. This means that for some hours, after the end of the drying cycle, the drum rotates at regular intervals to prevent the formation of creases.
 In case of power failure, it is necessary to press the "Start/Pause" button to restart the cycle.

Eco Monitor

This indicator shows the energy consumption level according to the programme and the options set. The consumption is proportional to the lines on the display, by the economonitor icon.

OPENING THE DOOR DURING THE CYCLE

Laundry can be checked while the drying cycle runs and any garments already dry can be removed, while drying continues for the remaining items. After closing the door, press the "Start/Pause" button to resume machine operation.

Keep the door closed until the cycle end to save time and energy.

NAVIGATION

The "UP" and "DOWN" buttons are used to navigate the available menus.

- Press the button to confirm the selection.
- Press the option button at the ⏪ symbol, where present on the display, to return to the previous screen.

If no selection is confirmed, after about 2 minutes, the display return to the main screen.

SETTINGS

To access the settings menu, keep the relevant button pressed for some seconds.

- **Set language** shows the available languages on the display.
- **Sounds** allows to enable or disable the sounds (some sounds, as warnings, will remain active anyway).
- **Brightness** allows to modify the display brightness.
- **Factory Default** allows to reset the default settings. After having selected the setting, keep the button pressed for some seconds.

CARE LABEL

Always check the care labels, especially when placing garments in the tumble dryer for the first time. Below are the most commonly used symbols:

- May be tumble dried.
- Do not tumble dry.
- Tumble dry – high heat.
- Tumble dry – low heat.





PROGRAMS

The duration of these programs will depend on the size of the load, types of textiles, the spin speed used in your washer and any extra options selected. **In machines equipped with display, the duration of the cycles is shown on the control panel.** The remaining time is constantly checked and adjusted during the drying cycle to show the best possible estimate. Option to use - If all your loads on Automatic Cycles are consistently less dry or more dry than you would like, you may increase or decrease the dryness level using the specific option.

 **Eco** **kg Max***
This is the most efficient programme in terms of energy consumption and is suitable for drying normal wet cotton laundry. The values on the Energy Label are based on this programme.

NOTE: For optimal energy efficiency this cycle by default is set up to "Cupboard Dry" level. For a higher dryness level we suggest using the Cotton cycle.

 **Cotton** **kg Max***
Cycle suitable for drying all types of cotton, ready to be placed in the cupboard.

 **Mixed** **kg 4**
This programme is ideal for drying cotton and synthetic fabrics together.

 **Synthetics** **kg 4**
For drying laundry made of synthetic fibres.

 **Wool 1** **kg 1**
Programme for drying wool clothes. It is advisable to turn the items inside out before drying. If heavy edges remain damp, leave them to dry naturally.

 **Delicates** **kg 2**
For drying delicate laundry requiring gentle treatment.

 **Bed Linen** **kg Max***
This programme is intended for drying cotton sheets.

 **Duvet**
Programme intended to dry bulky items, such as a single duvet.

 **Easy Ironing**
This cycle relaxes fibres, thus making ironing and folding easier. Suitable for small load of damp or dry cotton and cotton blend fabrics. Not for wet items.

More Cycles

 **Microfiber** **kg 2**
Gentle drying for microfiber.

 **Towel** **kg Max***
For drying sturdy cotton laundry, such as terry towels.

 **Technical Wear** **kg 4**
For drying synthetics or cotton technical wear.

 **Down Jackets** **kg 2**
To dry down jackets, restoring their natural softness (2 jackets).

 **Mats** **kg 3**
To dry small bath or kitchen mats. Do not dry mats with plastic parts, as this could cause a fire hazard.

 **Lingerie** **kg 2**
To dry very delicate underwear. Close all hooks before drying.

 **Cuddly Toys**
This cycle preserves the appearance of cuddly toys, keeping them at their best. Remove all accessories before proceeding with drying. Each single piece must not exceed 600 gr.

 **Mixed Colors** **kg 3**
Programme for the gentle drying of coloured fabrics.

 **Sport** **kg 4**
For drying synthetics or cotton sports garments.

 **Jeans** **kg 3**
For drying sturdy cotton including denim trousers and jackets.

 **Shirts** **kg 3**
This is a programme for cotton or cotton blend/synthetics shirts.

 **Rapid 30'** **kg 0.5**
Ideal for drying cotton garments spun at high speed in the washing machine.

Refresh

A short programme suitable for refreshing fibres and garments through the emission of fresh air. Do not use on wet items. It can be used on with any load size but is more effective with small loads. It lasts about 20 minutes.

***MAX LOAD 9 Kg (Dry load)**

OPTIONS

These buttons allow you to personalise the selected programme according to personal requirements. Not all options are available for all programmes. Some options may be incompatible with ones you have previously set; if so, you will be alerted by the buzzer and/or blinking indicators. If the option is available, the option indicator will stay on. The programme may retain some options selected in previous drying cycles.

Dryness Level

Press the relevant button several times to obtain a different level of residual moisture on your laundry. The display signals the level being selected. After few seconds of inactivity, the display returns to the main menu.

 **Iron Dry:** very delicate drying. Items will be more easily ironed immediately after the cycle.

 **Hanger Dry:** a level intended for delicate garments ready to be hanged.

 **Cupboard Dry:** the laundry is ready to be folded and put away.

 **Extra Dry:** for laundry intended to be worn at the end of the cycle.

Timed Drying

This option is to manually set the drying time. Press the corresponding button to set the required time for drying. An indicator on the control panel signals the time being selected.

Start Delay

This option is for delaying the start of the cycle. Press the corresponding button several times to find the required delay. Once the max time is reached, the option is reset by pressing the button again. An indicator on the control panel signals the time being selected. After pressing the "Start/Pause" button, the machine signals the time remaining to the start of the cycle. If the door is opened, press the "Start/Pause" button once the door has been closed.

FRESH CARE+ FreshCare+

If laundry is left inside of the drum once the cycle has ended, it can be subjected to bacterial proliferation. This option helps to prevent this from happening by controlling the temperature and gently rotating the drum. This will continue for up to 6 hours after the end of the cycle. This setting will remain in the memory of the previous cycle. If this is used alongside Start Delay, a crease treatment will be performed during this phase by periodic rotations of the drum.

Rapid

Enables quicker drying.

Key Lock

This option makes all machine controls inaccessible, except the "On/Off" button. When the machine is on:

- to activate the option, keep the button pressed until the machine signals that the option has been enabled.
- to disable the option, keep the button pressed until the machine signals that the option has been disabled.

This option remains in memory if selected in previous drying.



Cycle End Signal

This option activates a prolonged buzzer at the end of the cycle. Enable it if you do not think you will hear the normal sound at the end of the cycle. After having pressed the option button, it can be enabled or disabled using the "UP" and "DOWN" buttons. Press the button to confirm.

This option remains in memory, if selected in previous drying.

Cycle Option

This button provides access to the menu of options below. Scroll the options with the "UP" and "DOWN" buttons and press the button to confirm the selection.

-  **Gentle**
Enables a more gentle treatment of the laundry by reducing the drying temperature.
-  **Anti Tangle**
This option performs a special drum movement that reduces tangling and knotting of your clothes. It gives best results when used with smaller loads.

CARE AND MAINTENANCE

WARNING: unplug the dryer during the cleaning and maintenance procedures.

Emptying the water tank after each cycle (see Fig. A).

Pull the container out of the dryer and empty it into a sink or other suitable drain, then place it back properly. Do not use the dryer without having inserted the container back in place.

Cleaning the primary door filter after each cycle (see Fig. B).

Pull the primary door filter out and clean it by removing the lint from the filter surface under running water or using a vacuum cleaner.

Cleaning the secondary door filter when the relevant indicator turns on (see Fig. C).

Pull the secondary door filter out and clean it in all its parts by washing it under running water or using a vacuum cleaner.

Clogged filters - clean both door filters (see Fig. B, Fig. C). For optimal performance, dry the filters before inserting them back in place.

Do not use the dryer without having inserted all filters back in place properly first.

The filters are essential parts for drying. They are intended to collect the lint formed during the drying process. In case of clogged filters, the air flow inside the dryer would be seriously affected: the drying time would be longer, the energy consumption would increase and the dryer could be damaged. If these procedures are not carried out properly, the dryer may not start.

Autoclean

The maintenance of the bottom filter of this model is automatic. The dryer carries out cleaning when the sensors signal the need to do so. In this case, the machine goes on working even when the drying cycle is completed. An indicator on the control panel will signal the maintenance. **Do not switch the machine off during this phase.**



Cleaning the tumble dryer

- The external metal, plastic and rubber parts can be cleaned with a damp cloth.
- Clean the front air intake grille regularly (every 6 months) with a vacuum cleaner to remove any lint, fluff or dust deposits. Furthermore, remove any lint deposits from the filters area, using a vacuum cleaner every so often.
- Do not use solvents or abrasives.

TRANSPORT AND HANDLING

Never lift the dryer by holding on to its top side.

1. Unplug the dryer
2. Remove the water from the water tank completely.
3. Make sure that door and water tank are properly closed.

Power consumption			
off-mode (Po) - Watts	0.50		
left-on mode (PI) - Watts	2.00		
Programs	Kg	kWh	Minutes
Eco * 	9	2.12	250
Eco 	4.5	1.20	160
Synthetics	4	0.63	90

*This is the reference programme for the energy label and suitable to dry normal wet cotton laundry. This is the most efficient programme in terms of energy consumption for drying wet cotton laundry. (Standard/Default starting configuration)

Heat Pump System

The heat pump contains fluorinated greenhouse gases, contained in a hermetically sealed unit. This sealed unit contains 0.18 kg of the R134a gas. GWP = 604 (1 t CO₂).

PRODUCT DESCRIPTION

1. Water Tank (A)
2. Air Intake grille
3. Door filter: primary (B), secondary (C)

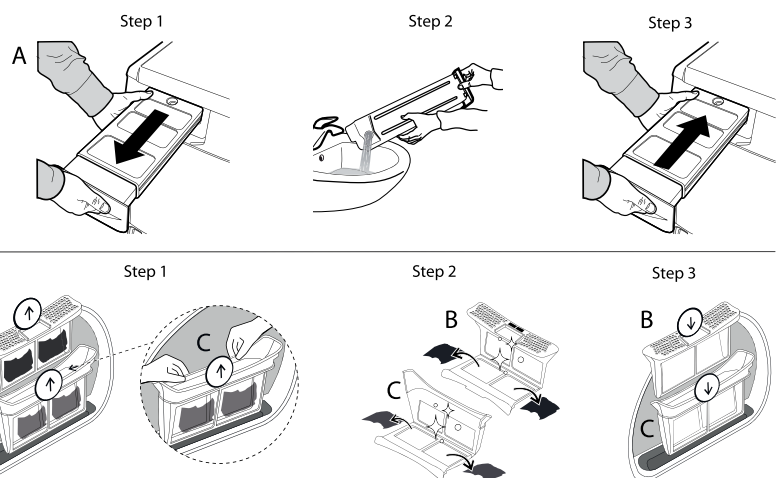
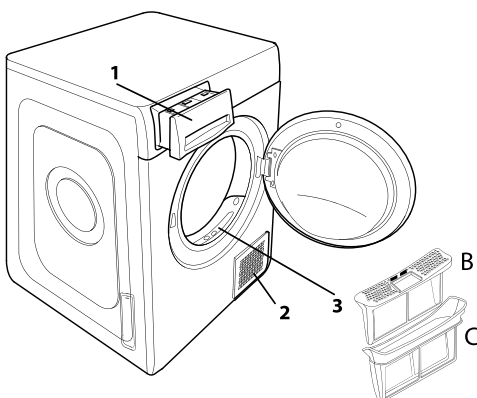

TROUBLESHOOTING

Before contacting the After-sales Service, refer to the table below. Often the malfunctions are minor and can be solved in few minutes.

Malfunction	Possible cause	Solution
The tumble dryer does not turn on.	The plug is not inserted into the socket.	Insert the plug into the socket.
	The plug is faulty.	Try to plug another appliance in the same socket. Do not use connecting electrical devices to the socket, such as adapters or extensions.
	A power failure occurred.	Wait for the power supply to be restored and switch the fuse on again if necessary.
The tumble dryer does not start.	The door has not been closed properly.	Close the door.
	A time delay was set to the start of the cycle.	For machines equipped with this function: wait for the set delay to end or switch the machine off to reset it. Refer to the Options section.
	The "Start/Pause" button was not pressed in order to start the programme.	Press the "Start/Pause" button.
	The Key Lock function was enabled (for machines equipped with this option).	Refer to the Options section. If Key Lock was selected, disable it. Switching the machine off will not disable this option.
Garments are wet at cycle completion.	Small load.	The automatic programme has not sensed the required final moisture so that the dryer completes the programme and stops. If this happens simply select an additional short period of drying or select Extra Dry option if available.
	Large loads or heavier fabrics.	Dryness levels can be modified to the specific dryness desired. Extra Dry is recommended for ready to wear items.
The drying times are very long.	An appropriate maintenance was not carried out.	Refer to the Care & Maintenance section and perform the operations described.
	The programme, the time and/or the drying level set are not suitable for the type and the amount of load inserted into the dryer.	Refer to Programmes and Options sections to find the programme and options most suitable for the type of load.
	The garments are too wet.	Carry out a washing cycle with higher spin speed to remove as much water as possible.
	The dryer may be overloaded.	Refer to the Programmes section to check the max load for each programme.
	Room temperature.	The drying time may be longer if the room temperature falls outside the 14–30°C range.
The programme did not end.	A power failure occurred might have occurred.	In case of power failure, it is necessary to press the "Start/Pause" button to restart the cycle
Lights on or flashing		
Water tank	The water tank is full.	Empty the water tank. Refer to the Care & Maintenance section NOTE: if using the direct drain system, check if hose is bent or squeezed. In that case straighten it up and remove any objects pressing it.
Door filter	Failure of the air flow necessary for machine operation.	Clean the door filter and check whether air intake is free. Carrying out these operations improperly may cause damages. Refer to Care & Maintenance section.
Bottom filter*	The bottom filter requires cleaning.	Clean the bottom filter. Refer to Care & Maintenance section.
DEMO The cycle lasts few minutes.	The dryer is in DEMO mode. The DEMO indicator is on.	Disable the DEMO mode. The following actions must be carried out in sequence, without breaks. Switch the machine on and then switch it off again. Press the "Start/Pause" button until the buzzer is heard. Switch the machine on again. The machine signals that the function was disabled.
The presence of wrench symbol signals a malfunction.	The machine sensors detected a failure.	Switch the dryer off and unplug it. Open the door immediately and pull laundry out, to allow the heat to dissipate. Wait for about 15 minutes. Reconnect the dryer to the power supply, load the laundry and restart the drying cycle. If the problem still occurs, contact the After-Sales Service Centre and communicate the letters and digits flashing on the display. For instance: F3 and E2.

*Note: some models are auto-cleaning and not equipped with bottom filter. Please refer to the Care & Maintenance section.

Standard documentation and additional product information can be found by:

- Visiting our website www.whirlpool.com.hk / www.whirlpool.com.sg
- Alternatively, **contact our After-sales Service** (See phone number in the warranty booklet). When contacting our After-sales Service, please state the codes provided on your product's identification plate.

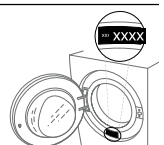

使用說明書



感謝您購買惠而浦產品
為了獲得更完善的服務，
請於 www.whirlpool.com.hk/www.whirlpool.com.sg
註冊您的產品

索引

使用說明書	11
安裝指引	12
安全指引	13
控制面板	15
顯示屏指示燈	15
首次使用	15
日常使用	15
當程序運行時打開機門	15
功能導航	15
設定	15
乾衣衣物護理標籤	15
程序	16
選項	16
清潔和保養	17
清潔乾衣機	17
搬運和處理	17
產品描述	17
故障排除	18
貼上中文程式標籤	19

 此符號提示你於使用乾衣機前請先細閱產品安全指引。請妥善保存此產品安全指引及使用說明作將來參考。本手冊和乾衣機本身提供重要的安全警告，請按需要隨時讀取及查察。不當的使用及不當的操作可能會導致的風險，製造商將不負任何責任。

 除非得到持續監視，否則幼兒(0-3歲)和兒童(3-8歲)應遠離乾衣機。乾衣機可由8歲以上之兒童及身體、感官或精神障礙或經驗知識不足的人士操作，前提是此等人士已接受使用乾衣機的安全指導及指引，且瞭解使用乾衣機的相關危險。

兒童不可胡亂玩弄乾衣機。未經指導，兒童不可進行乾衣機的清潔及保養工作。

 警告：烘乾程序結束前切勿停止乾衣機運作，除非所有烘乾物件均可快速取出且鋪開散熱。

 衣物如沾有食用油、丙酮、酒精、汽油、煤油、松脂、去污劑、蠟及除蠟劑，以及泡沫橡膠(乳膠發泡體)、塑膠浴帽、防水紡織品、帶橡膠配件的物品與衣物或裝有泡沫橡膠墊的枕頭等物品不得使用本乾衣機烘乾。

請取出衣物口袋中的所有物品，例如打火機和火柴。若曾經使用化學劑清潔衣物，請不要使用乾衣機烘乾。

 經過油浸的衣物具有高度易燃性，不可放於乾衣機內烘乾。

 切勿強行打開機門或以它作為踏板使用。

允許使用

 注意：此乾衣機不能透過外部控制器或遙控裝置進行操作。

 此乾衣機設計只適用於家居或下列之類似環境：如一般商店、辦公室及其他工作環境的職員專用廚房；農莊；供入住酒店、汽車旅館及其他住宅式旅店之顧客使用；提供簡單住宿及早餐服務之旅舍。

 此乾衣機不適用於專業用途，請勿於室外使用此乾衣機。

 任何易燃的物品(如汽油、氣霧罐)，請勿放近乾衣機。

 請確保負載不超過最大乾衣量(請參閱「程序」篇章中的指示)。

 請勿使用乾衣機烘乾未經清洗衣物。

 請留意有沒有棉絨或塵埃堆積在乾衣機周圍。

 若使用衣物柔軟劑或同類產品應根據產品說明書的規定使用。

 不要過度烘乾衣服。

安裝

 此乾衣機建議由兩個或更多的人進行安裝處理，避免受傷風險。使用防護手套來執行所有拆封和安裝操作，避免割傷風險。

 安裝，包括供水(如有)，及任何電線接駁，必須由合資格的技術人員按照製造商的說明和本地標準安全法規進行維修。除非在用戶手冊特別聲明，切勿維修或更換任何乾衣機的部件。

兒童應遠離乾衣機安裝地點。卸下包裝後，確認它沒有在運輸過程中損壞。在出現問題時，請聯絡經銷商或售後服務中心。當完成安裝後，包裝材料(如塑膠，發泡膠件等)應置於幼童無法取得的地方，避免意外的風險。此乾衣機進行安裝前，必先斷開它的電源連接避免觸電危險。進行安裝時，確保乾衣機電源線沒有損壞，避免火災或觸電危險。只有當安裝步驟完成後才可啟動乾衣機。

 請確保空氣流通(將門、大於500厘米平方的通風格或通風槽打開)，避免乾衣機排氣回流至室內，引致燃燒其他燃料，包括明火。

如果乾衣機安裝至廚櫃底，請由乾衣機頂部至廚櫃之間預留10毫米空間，而乾衣機兩旁的側面板與廚櫃壁之間，亦需預留15毫米空間。

 如果乾衣機被安裝於煤氣爐或煤炭爐旁邊，請於乾衣機與煤氣爐或煤炭爐中間，安裝隔熱板(85厘米 x 57厘米)，而面向煤氣爐或煤炭爐一方的乾衣機面板，需要以鉛箔覆蓋。

 切勿將乾衣機連接至用來排放燃燒氣體或其他燃料的排氣管道。

 不得將此乾衣機安裝於下述類型的門的後方：包括帶鎖門、滑動門或當門鉸與乾衣機機門方向相反時，因為這些情況下會令乾衣機機門不能完全打開。

 乾衣機必須靠牆擺放，以確保機件背部不會被觸碰。

 請勿使地毯堵塞乾衣機底部排氣孔。

 如果要在洗衣機頂部放置乾衣機，請首先聯繫我們的售後服務中心或您的經銷商，以取得可行型號的列表。只允許使用我們的售後服務中心或您的經銷商提供的專業疊裝工具將乾衣機固定在洗衣機上。固定架套件中附有組裝及使用說明。

電氣警告

 插座必須能夠拔掉，以切斷電源，或安裝設有開關鍵的插座及按照本地的電器安全標準法連接地線。

 請勿使用接駁電線或萬能插頭，安裝後電線部份不可被使用者易於接觸。手濕或赤腳時請勿使用本產品。若本產品的電源線或插頭有損壞，不能正常運作，或受損，請勿操作。

 如果電源線損壞，必須根據相同產品更換電源線。電源線只能由製造商指定的技術人員更換以避免觸電的危險。

清潔和保養

 注意：執行任何維修或清潔操作之前，請先關閉及拔下電源插頭。使用防護手套和穿上保護鞋來執行所有操作，避免割傷及挫傷風險。建議由兩個或更多的人進行清潔時的搬運處理，避免受傷風險。切勿使用蒸氣清洗本產品。

切勿進行任何並非由製造商授權的維修，以避免受傷和安全風險。任何因此導致的損壞，製造商將不負任何責任。

 必須確保已經清潔所有棉絨才開始乾衣程序。

處理包裝物料

包裝材料完全可回收，並設有可回收標誌 。
包裝的各個部分必須根據當前本地廢品處理法規進行處理。

廢棄家用電器

必須根據當前本地廢品處理法規進行處理。有關處理、修復和回收本產品的詳細資訊，請聯繫售後服務中心、家庭廢品處理服務中心或您購買本產品的商店。

本乾衣機依照有關廢棄電器和電子設備(WEEE)的歐盟標準2012/19/EU標示。確保以正確的方式廢棄本產品，可避免因不當的廢棄處理方式而對環境和人體健康造成潛在的負面影響。

這符號  表示此機器不能作為家庭廢品處理。應將它交給回收電器和電子設備的適用收集點。

感謝您購買惠而浦產品



為了獲得更完善的服務，請於
www.whirlpool.com.hk註冊您的產品。
www.whirlpool.com.sg



使用此產品前，請細心參閱「產品安全指引、使用說明及安裝指南」

控制面板

1. 程序選擇旋鈕
2. 電源「開/關」鍵
3. 「啟動/暫停」鍵

功能鍵

4. 「清爽抗皺」
5. 「結束蜂鳴」
6. 「快速」
7. 「選項」(設定請長按)
8. 「乾衣程度」
9. 「乾衣時間」
10. 「預校開機時間」

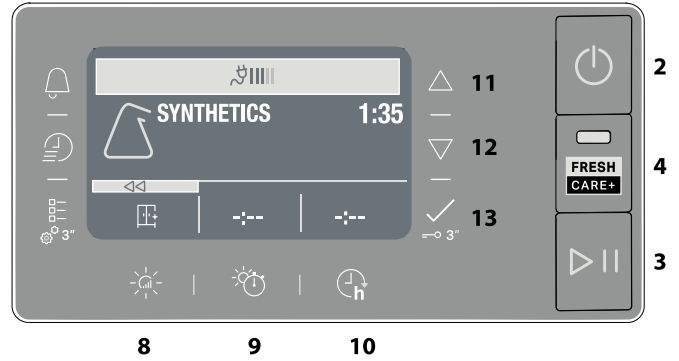
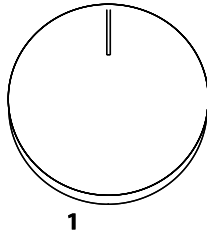

導航按鈕及兒童安全鎖

11. 向上
12. 向下
13. 確定 (兒童安全鎖請長按)

顯示屏指示燈

乾衣階段指示： 乾衣 冷卻 程序結束

清空儲水盒 清洗外層機門過濾器 機門過濾器堵塞 自動清潔 耗電量

請參考「故障排除」篇章： 故障指示：聯絡服務中心 DEMO 示範模式

首次使用

當乾衣機第一次被啟動，顯示屏會顯示設置語言的畫面，按「向上」或「向下」按鈕瀏覽可選擇之語言，按 鍵確認設定所選語言。如未設置語言將導致乾衣機無法使用。請確保儲水盒安插正確。

乾衣機應該安裝於室溫 5°- 35°C 之環境下使用，以確保操作穩定。安裝完成後等待至少6小時使其適應室內的環境，才可開始使用。如需更改開門方向，請聯絡售後服務中心。

日常使用

下列步驟可使你的乾衣機達至最佳表現效能。每個乾衣程序完成後，謹記清空水槽，以及清潔過濾網。
(請參閱「清潔和保養」篇章。)

1. 將插頭插在插座內。
2. 打開機門，放入衣物。請查閱衣物護理標籤上的指示，以及「程序」篇章所指出的最大建議乾衣量操作。清空衣物口袋，確保衣物沒有被卡住於機門玻璃和機門過濾器之間。避免放入過濕或過大件衣物。
3. 關閉機門。
4. 按下電源「開/關」鍵。
5. 設定所需的程序。
6. 選擇選項(如有需要)。
7. 如需啟動程序，按「啟動/暫停」鍵。
8. 乾衣程序結束後，會響起「唸」聲。控制面板上的指示燈亮起，表示程序已經完結。此時應立即將衣服取出以防摺痕形成。
9. 按下電源「開/關」鍵，以關閉乾衣機，打開門並將衣服取出。如果乾衣機未有手動關機，則在程序結束約15分鐘後，乾衣機會自動關閉，以節省能源。對於某些配備抗皺護理功能的型號，系統會在完成程序的幾個小時，滾筒以規則的間隔旋轉，防止摺痕形成。如果出現電源故障，必須按下「啟動/暫停」鍵，重新啟動程序。

耗電量顯示

提供關於所選擇程序及選項之電源耗用的粗略估計。程序設定預測耗用的電量越少，亮起的指示燈就越少。

當程序運行時打開機門

當程序運行時，您仍可打開乾衣機機門，檢查並拿出已烘乾好的衣物，然後繼續烘乾其它衣物。當門被關上，按下「啟動/暫停」鍵，程序將重新啟動。在乾衣程序期間保持機門關閉更有效節省時間和能源。

功能導航

「向上」或「向下」按鈕是用作瀏覽各功能的可用選項。

- 按下 以確認啟用各選項。
- 當 圖標出現時，按下旁邊的「選項」鍵，以返回上一個畫面。

如果於兩分鐘內沒有進行任何選擇，將會返回主目錄。

設定

長按相關按鈕以更改以下設定：

- 顯示語言
- 按鍵音：調校或關閉按鍵音(除警告音外)。
- 顯示對比度：調校顯示屏亮度。
- 回復出廠設定：長按 鍵以完成設定。

乾衣衣物護理標籤























經常檢查護理標籤，尤其當你第一次使用乾衣機時。下列為常用圖標：

- 可以烘乾
- 不可烘乾
- 適合高溫烘乾
- 適合低溫烘乾



程序

程序的時長短受負載量、布料類型、洗衣時所用轉速以及所揀選的選項影響。程序所需時間會顯示於備有顯示屏幕的乾衣機的控制面板上。於烘乾程序進行中，系統會經常監察並調整程序剩餘時間。乾衣程度調整 – 如負載過濕或過乾，可透過相關按鍵增加或減少乾衣程度。

-  **棉質節能 (*最高負載量(公斤))**
標準棉質程序，適用於烘乾一般濕的棉質衣物。這是烘乾棉質衣物能源效益最佳的程序。備註：為達到最佳能源效益，此程序默認使用「一般乾衣」程度。如需增強烘乾效果，建議選用「棉質」程序。
-  **棉質 (*最高負載量(公斤))**
用於烘乾棉質衣物，乾衣程序結束後可摺疊放入衣櫥的衣物。
-  **混合衣物 (4公斤)**
適用於烘乾由棉、麻、人造纖維及其混合織物製成的衣物。
-  **合成纖維 (4公斤)**
用於烘乾由合成纖維製成的衣物。
-  **羊毛 (1公斤)**
羊毛衣物的乾衣程序。建議在乾衣前將衣物翻出來。對於仍然潮濕的邊緣位置，請於完成程序後掛起風乾。
-  **纖細衣物 (2公斤)**
用於烘乾需要溫和處理的精緻衣物。
-  **床單 (*最高負載量(公斤))**
此程序專為烘乾棉質床單而設。
-  **大型物件**
適用於烘乾如睡袋，可拆洗棉被。
-  **易熨防皺**
此程序可放鬆衣物纖維，令熨燙及摺疊衣服變得更容易。當衣服濕透時，不要使用此程序。此程序適用於較輕負載量的棉質布料或棉質混紡上。
-  **更多乾衣程序**
 -  **微纖維 (2公斤)**
輕柔烘乾微纖維衣物
 -  **毛巾 (*最高負載量(公斤))**
用於烘乾棉質毛巾，例如毛圍布。
 -  **專業運動衣物 (4公斤)**
用於烘乾合成纖維或棉質專業運動衣物。
 -  **羽絨 (2公斤)**
用於烘乾厚大服裝，如羽絨服(最多2件)。
 -  **地毯 (3公斤)**
用於烘乾較細的浴室或廚房毯布。注意不可放入含有塑膠物料的毯布，避免火災危險。
 -  **內衣 (2公斤)**
用於烘乾需要溫和處理的精緻內衣。烘乾前應先把內衣扣扣好。
 -  **玩偶**
用於烘乾玩偶，令其保持完整狀態。烘乾前應先除下所有玩偶上的配飾。每件玩偶不得超過 600克。
 -  **顏色衣物 (3公斤)**
用於烘乾需要溫和處理的顏色衣物。
-  **運動衣物 (4公斤)**
用於烘乾合成纖維或棉質製成的運動服裝。
-  **牛仔布 (3公斤)**
適用於烘乾類似牛仔布堅固物料製成的棉質牛仔褲、外套等。
-  **襯衣 (3公斤)**
適用於由棉質、麻、合成纖維及混合纖維製成的襯衫、上衣。
-  **30分鐘速乾 (0.5公斤)**
用於快速烘乾洗衣時使用高轉速脫水的棉質布料。



清新

此程序需時較短，可令衣物布料帶來清爽效果。不適用於仍然濕的衣服。它可以用於任何負載量的衣物，但在較少負載量時效果會更好。程序持續時間大約為20分鐘。

*最大乾衣量9公斤(乾衣重量)

選項

這些選項可根據個人要求而揀選。

並非所有選項都適用於所有程序。某些選項與先前設置的選項並不兼容。蜂鳴器和/或閃爍指示燈將指示所選的程序及選項的不兼容性。如果該選項可使用，則選項指示燈將保持亮起的狀態。如果在先前的乾衣程序中已選擇，系統將預設啟用某些選項。



乾衣程度

按下相關的按鈕數次，以調校不同的乾衣程度，指示燈會亮起，以表示正在選擇的程度級別。如果於數秒內沒有進行任何選擇，將會返回主目錄。



熨燙乾衣：柔和的乾衣方法。於程序完結後，立即熨燙衣物會變得更容易。



防皺乾衣：適用於準備懸掛，而且較纖細的衣物。



一般乾衣：適用於在乾衣程序結束後摺疊放入衣櫥的衣物。



額外乾衣：適用於在乾衣程序結束後，立即穿著的衣物。



乾衣時間

此選項允許設定特定乾衣時間。按下相應按鈕設定乾衣時間，控制面板上所屬時間的指示燈會相應地亮起。



預校開機時間

此功能可讓您設定延遲程序的開始時間。按下相應的按鈕數下，以選取所需的延遲時間。當到達時間最大值，再次按下按鈕可重設選項。控制面板上的指示燈表示正在選擇的時間。按下「開始/暫停」鍵後，乾衣機會發出程序開始的剩餘時間信號。若此時機門打開，於關閉後，必須再次按下「開始/暫停」鍵。



清爽抗皺

如果衣物在程序結束後仍留在滾筒內，細菌會於衣物上繁殖。該選項允許通過控制滾筒的溫度和旋轉，來防止細菌擴散。此功能最多可於乾衣程序結束後持續6小時。若於先前的乾衣程序中已有選擇此選項，系統將預設啟用此選項。如果此選項與「預校開機時間」一起使用，則會在「預校開機時間」階段添加皺摺處理(滾筒的周期性旋轉)功能。



快速

加快乾衣的速度。



兒童安全鎖

除電源「開/關」鍵外，此選項使所有按鈕被鎖定。乾衣機開啟時：

– 要啟動此選項，請按住此按鈕直至指示燈亮起。

– 要停止此選項，請按住按鈕直到指示燈熄滅。若於先前的乾衣程序中已有選擇此選項，系統將預設啟用此選項。



結束蜂鳴

此選項可在程序結束時，啟動延長蜂鳴器的功能。如果您不確定在程序結束時聽到正常程序完結的聲音，請啟動它。按下「選項」鍵後，按「向上」或「向下」按鈕即可啟動/停止此選項，按下 以確認。

如果在先前的乾衣程序中已選擇，系統將預設啟用此選項。



選項

按下此鍵以啟用下列其它選項。按「向上」或「向下」按鈕以選擇所需選項，最後按下 以確認。

•  **輕柔**

通過降低烘乾溫度令衣物護理變得更柔和。

•  **防結纏**

通過特定的滾筒旋轉機制以減少衣物結纏，在較少負載量時效果會更好。

清潔和保養

警告：在進行清潔和維修過程中，請先拔除乾衣機電源插頭。

 在每個程序完成後，清空儲水箱（請參看圖A）。將儲水箱從乾衣機中拉出，然後將水倒入水槽或其他合適的排水箱中，然後將儲水箱放回原位。若未能將儲水箱放回原位，請勿使用乾衣機。

在每個程序完成後，清潔內層機門過濾器（請參看圖B）。將過濾器拉出並通過在水流下或使用真空吸塵器除去棉絨來清潔過濾器。

 當相關指示燈亮起時，清潔外層機門過濾器（請參看圖C）。將過濾器拉出並通過在水流下或使用真空吸塵器除去棉絨來清潔過濾器。

 機門過濾器堵塞，清潔內層及外層機門過濾器（請參看圖B, C）。為獲得最佳效果，請先將所有過濾器弄乾，然後再將其安置回原位。

如果沒有將過濾器放回正確位置，請勿使用乾衣機。

過濾器是乾衣機的必要部件。它們用於收集乾衣過程中形成的棉絨。如果過濾器堵塞，乾衣機內的氣流將受到嚴重影響：乾衣時間會更長，能源耗用量會增加，乾衣機可能會損壞。如果這些步驟沒有正確執行，乾衣機可能無法啟動。

自動清潔

乾衣機會自動感測並於需要時進行底部過濾器的清潔。當進行自動清潔時，顯示屏上會出現相關指示燈，而乾衣機會於完成乾衣程序後繼續運作，請勿關閉乾衣機。



清潔乾衣機

- 用濕軟布清潔乾衣機的外部。
- 定期使用真空吸塵器清潔底部進氣口位置（每6個月），除去棉絨、灰塵等。另外，經常清潔過濾網位置的棉絨。
- 不要使用溶劑或研磨劑進行清潔。

搬運和處理

搬運時，切勿提拉乾衣機的頂板。

1. 拔除乾衣機電源插頭。
2. 清空儲水箱的水。
3. 檢查並確定機門和儲水盒都已正確關閉。

能源耗用量			
關閉模式功率消耗 (Po) - 瓦特			0.50
備用模式功率消耗 (Pi) - 瓦特			2.00
程序	公斤	千瓦/小時	分鐘
棉質節能* 	9	2.12	250
棉質節能 	4.5	1.2	160
合成纖維	4	0.63	90
* 這是能源標籤的參考程序，適用於烘乾普通濕棉質衣物。這是就能源消耗而言，烘乾濕的棉質衣物最有效的程序。（標準/預設啟動配置）			

熱泵技術

熱泵技術使用密封的氟化溫室氣體作烘乾。

產品描述

1. 儲水箱 (A)
2. 進氣口
3. 機門過濾器：內層 (B)，外層 (C)

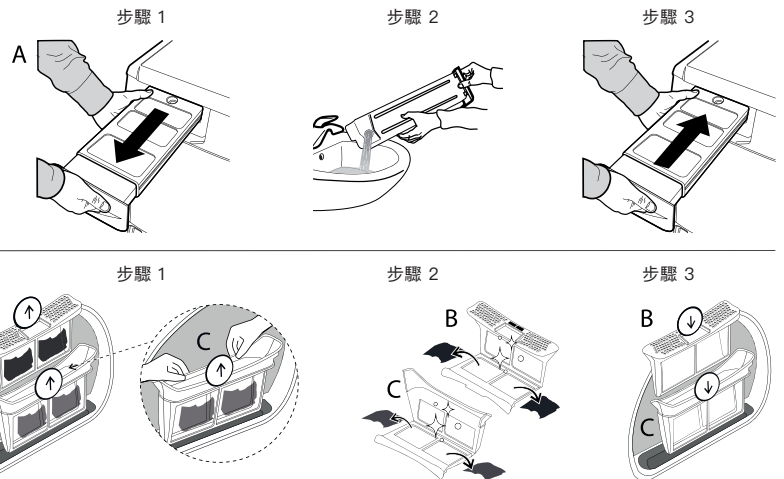
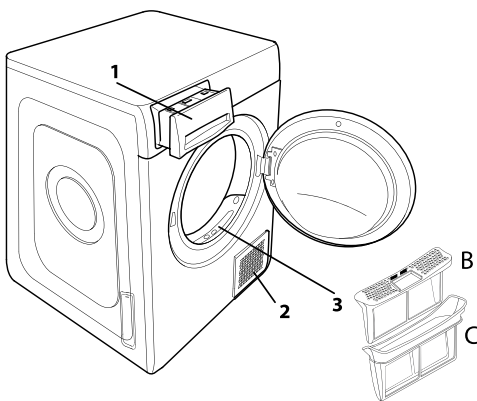

故障排除

聯絡售後服務中心之前，建議先自行進行檢查，看問題是否可以使用下列的簡易方法解決。通常故障是輕微的，可以在數分鐘內解決

問題	可能原因	解決方法
乾衣機無法啟動	插頭沒有正確插在插座內。	將插頭正確插在插座內。
	插頭故障。	嘗試將另一台機器重新連接同一插座。請勿使用連接器或萬能插頭連接機器至插座。
	電源故障。	等待電力供應恢復。如有需要，重新連接保險絲。
乾衣程序無法啟動	機門未正確關閉。	將機門關上。
	已設定預校開機時間。	對於配備此選項的乾衣機：等待「預校開機時間」結束或關閉乾衣機以重置它。請參閱「選項」篇章。
	沒有按下「啟動/暫停」鍵。	按下「啟動/暫停」鍵，再次啟動乾衣機。
	啟用了兒童安全鎖（適用於配備此選項的型號）。	請參閱「選項」篇章，如果正啟動兒童安全鎖，請停用此選項。關閉乾衣機並不能停用此選項。
衣物不夠乾	負載過少。	乾衣機內置感應器無法正確感應衣物濕度狀態並完整完成程序。建議可透過延長乾衣時間或選擇「額外乾衣」達至理想烘乾效果。
	負載過多或放入了過重衣物。	按需要調整乾衣程度，如需要在乾衣結束後立即穿著，建議選擇「額外乾衣」。
乾衣時間太長	沒有進行適當的清潔和保養。	請參考「清潔和保養」篇章，並執行所述操作。
	程序、時間和/或乾衣程度設定不適合放入乾衣機的負載類型和重量。	請參閱「程序」和「選項」篇以查找最合適負載類型的程序和選項。
	衣物太濕。	以更高的旋轉速度進行洗衣程序，盡可能去除多餘水份。
	乾衣機負載量過多。	請參閱「程序」篇章，以檢查個別程序可加載的最大負載量。
	室溫不適合乾衣機操作。	如室溫超出14–30°C範圍，乾衣時間可能會延長。
乾衣程序一直未結束	可能發生了電源故障。	於恢復供電後，必須按下「啟動/暫停」鍵，再重新啟動程序。

提示燈亮起或閃爍

儲水箱	儲水箱太滿。	清空儲水箱。請參考「清潔和保養」篇章。 如將排水管連接到家中排水池，需確保排水管沒有被扭曲或擠壓。
機門過濾器	乾衣機運行所需的空氣流動失效。	清潔機門過濾器並檢查空氣流動是否順暢。不正確地進行這些操作可能會對乾衣機/衣物造成損害。請參考「清潔和保養」篇章。
底部過濾網*	需要清潔底部過濾網。	清潔底部過濾網。請參考「清潔和保養」篇章。
示範模式 程序維持數分鐘	乾衣機正處於示範模式。	要暫停使用示範模式，必須按順序執行以下操作，不得中斷。啟動乾衣機，然後關閉它，按下「啟動/暫停」鍵，直到聽到蜂鳴聲，再次啟動乾衣機。「示範模式」指示燈閃爍，然後熄滅。
顯示屏上出現故障符號	乾衣機的感應器檢測到故障。	關閉乾衣機並拔下電源插頭。立即打開機門，將衣物取出，讓熱量消散。等待大約15分鐘。將乾衣機重新連接到電源，放入衣物並重新開始乾衣。如果問題仍然存在，請聯繫售後服務中心並向我們說明顯示屏上閃爍的字母和數字。例如：F3和E2。

* 備注:某些配備自動清潔功能的型號不備有過濾器於產品底部。詳情請參閱「清潔和保養」篇章。

可從下列途徑下載本說明書：

- 於網站內下載 – www.whirlpool.com.hk / www.whirlpool.com.sg
- 致電售後服務中心(請參閱保養書上的電話號碼)，請提供乾衣機門內側顯示的代碼。

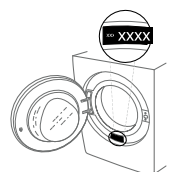

Chinese program label placement

貼上中文字式標籤

Place the label (available in documentation bag) as indicated in the graphic below. Avoid applying on the touch panel.

請將中文程式標籤（附於文件袋內）貼於下圖的指定位置，避免貼到輕觸式屏幕範圍。

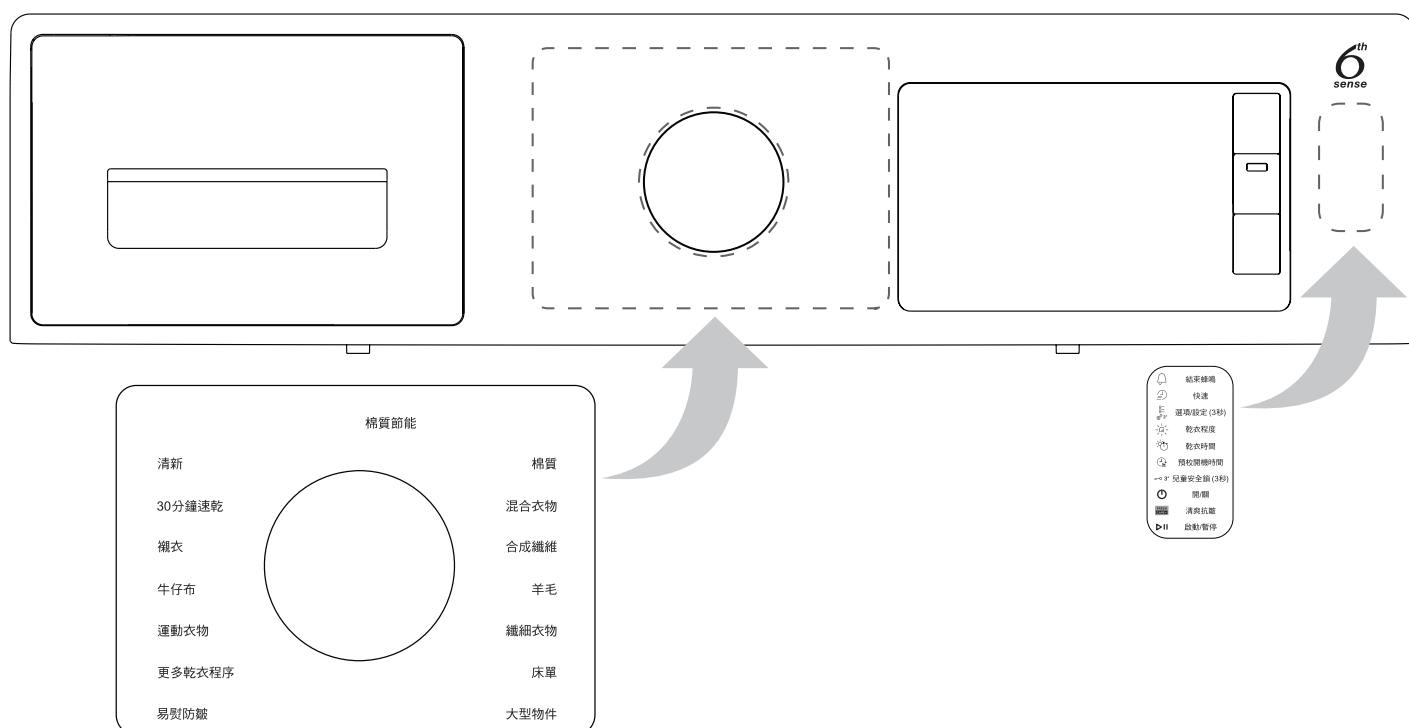

Register your product online

網上登記新產品保養

For Singapore Warranty, please scan QR code or visit below website:



<https://www.whirlpool.com.sg/>

For Hong Kong Warranty 香港地區保養

Save the planet and register your product warranty online!
Enjoy extra 1-month free warranty upon online registration.

「惠」環保出力，減少用紙!於網上登記產品更可獲額外多一個月保養。



<https://rebrand.ly/WPwarranty>

Whirlpool® Registered trademark/TM Trademark of Whirlpool group of companies

All rights reserved

註冊商標/惠而浦集團的TM商標

版權所有 翻印必究

