

SPECIFICATIONS

Whirlpool

Automatic Washing Machine

	WVTD1050AHG	WVTD1050BHG
Dimensions	570 (W) X600 (D) X975 (H) mm	570 (W) X600 (D) X975 (H) mm
Weight	40kg	40kg
Water quantity (HIGH)	75L	75L
Voltage	AC 220-240V~50hz	AC 220-240V~/60hz
Input Power	300W	300W
Required Water Pressure	0.03 MPa – 0.8 MPa	0.03 MPa – 0.8 MPa

Model: WVTD1050AHG
WVTD1050BHG

WARNING - This appliance must be earthed.

FOR WASHER PLUG 3 PIN (BS Standard Plug With 13 Amp Fuse)

The wires are coloured in accordance with the following code:
Green/yellow: Earth Light Blue: Neutral Brown: Live

The wires in the appliance may not correspond with the coloured markings identifying the terminals in your plug, proceed as follow :

- The wire which is coloured green and yellow must be connected to the terminal in the plug which is marked with the letter E or by the earth symbol \perp or coloured green or green and yellow.
- The wire which is coloured light blue must be connected to the terminal which is marked with the letter N or coloured white.
- The wire which is coloured brown must be connected to the terminal which is marked with the letter L or coloured black.

FOLLOWING CAUTIONS ARE FOR WASHER USING DOUBLECORE CORD ONLY.

- If the 2-pin type socket-outlet has a grounding terminal, attach the end of the Grounding Wire to the terminal.
- When grounding the washer, connect the grounding wire before plugging in the Power Cord.
- If the 2-pin type socket-outlet has no grounding terminal, consult your nearest dealer or attach the end of Grounding Wire to a suitable grounding point, such as a metal water pipe.
- Never connect the Grounding Wire to a gas pipe.
- Unplug the Power Cord before disconnecting the Grounding Wire.

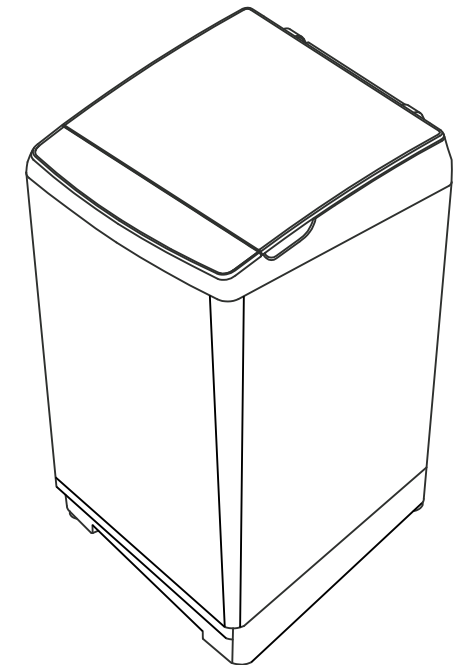
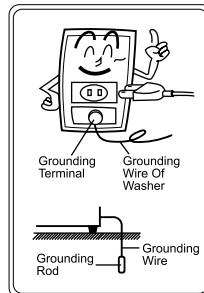



Table of Contents









Precautions -----	2~4
Notes on Maintenance -----	4
Packing Instructions -----	5
Parts Names -----	5
Installation Instructions -----	6~8
Washing Tips -----	8
Description of Operation Panel Functions -----	9~10
Quick Start -----	11~12
Program Customization -----	12~13
Textile Program Instructions -----	14
Wool Program Instructions-----	15
Description of other Functions, Method for Setting These Functions -----	16~18
Preset Time/Schedule Function -----	16
Smart Memory Function -----	16
Two-step Clean Function -----	16
Variable Wave Function -----	17
Water Level (Varied Wash) Function -----	17
Residual Water Draining Function -----	17
Tub Light -----	17
Soak Function -----	17
Energy-saving Function -----	17
Program Midway Change Function -----	18
Child Lock Function -----	18
Disabling Beeps -----	18
Troubleshooting Guide -----	19
Non-malfunction Cases -----	20

Precautions

- Please read the precautions carefully before using this product.
- This appliance is not designed to be used by persons with insufficient physical, sensory or mental functions (including children) or without experience and knowledge unless when such person uses this product, he/she is supervised or guided by another person who can ensure his/her safety to prevent a fire or injury from occurring.
- In order to avoid any property damage or personal injury to the user, we hereby give the following notes on matters that need to be observed in respect to safety:













 Warning	Contents with this mark indicate that there may be the possibility of death or injury.
 Caution	Contents with this mark indicate that there may be the possibility of injury or object damage.

		
Warning or Caution Contents.	Prohibited Contents.	Advisory Contents.

 Warning	
 Non qualified or inexperienced personnels are not allowed to disassemble or repair the Washing Machine. • Fires, electric shocks or injuries may occur. • Please report to the company when a breakdown occurs.	 Do not bend, pull or twist the Power Cord too much. • The Power Cord may be damaged leading to fires or electric shocks.
 During maintenance, please be sure to unplug the Power Cord from the outlet and not to unplug the Power Cord with wet hands. • Electric shocks or injuries may occur.	 Do not use voltages other than 220V. • Injuries, fires or electric shocks may occur.
 Do not use a damaged or loosened Power Cord or Power Cord Plug. • Fires may occur. Electric shocks or short circuits may cause injuries or fires.	 Dust and other dirt on the Power Cord Plug shall be removed regularly. • If dust accumulates on the Power Cord, a fire may occur due to poor insulation caused by moisture.
 Do not use the Washing Machine for other purposes. • This Washing Machine shall not be used for other purposes except for the washable clothes specified in the instructions to prevent any danger or damage to the Washing Machine from occurring.	 Do not place it in an unsteady place. • The Machine may topple over or move due to external forces and thereby cause personal injuries or damage to the Machine.



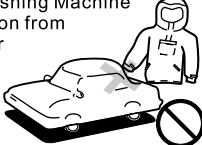





Precautions

⚠ Warning



<p>Do not put your hands in the Drum while the Washing Machine is running.</p> <ul style="list-style-type: none"> •If you touch the Drum, you may be injured. •During spin-drying, if the Drum does not stop rotating 15 seconds after the Drum Cover is opened, please turn off the power and call the company's Customer Service number as soon as possible.  <p>Do Not Touch</p>	<p>Do not wash clothes stained by volatile solvents.</p> <ul style="list-style-type: none"> •Do not wash the clothes stained by gasoline, kerosene, thinner, etc. This may cause fires or explosions.  <p>Prohibitions</p>
<p>Please be sure it is grounded properly.</p> <ul style="list-style-type: none"> •To avoid current leakage accidents.  <p>The socket shall be grounded properly</p>	<p>Do not install it in a humid or rainy place.</p> <ul style="list-style-type: none"> •Poor electrical insulation may cause current leakage or malfunction.  <p>Prohibitions</p>
<p>Do not allow children to play on the Washing Machine or in the Drum.</p> <ul style="list-style-type: none"> •If a child accidentally falls into the Drum, it can cause serious injury.  <p>Prohibitions</p>	<p>Do not use a socket of a voltage other than 220V.</p> <ul style="list-style-type: none"> •This may result in a risk of injuries, fires or electric shocks. •Please use an independent socket of more than 10A. Do not use a power strip or share a power supply with other electric appliances.  <p>Prohibitions</p>
<p>Plugging and Unplugging of the Power Cord.</p> <ul style="list-style-type: none"> •When plugging or unplugging the Power Cord, the fingers must grip the insulation part of the Plug without touching the metal pins of the Plug to prevent an electric shock from occurring or force being applied to the wire and thereby resulting in breakage of the wire inside the Power Cord. •When moving the Washing Machine, be sure to unplug the Plug of the Power Cord.  <p>Prohibitions</p>	<p>Keep the Machine away from fires.</p> <ul style="list-style-type: none"> •Keep the Machine away from fires. Do not place lit candles, cigarettes or mosquito coils or kettles on the Washing Machine. This is the main cause of fires or deformation.  <p>Prohibitions</p>
<p>Protection of the Power Cord.</p> <ul style="list-style-type: none"> •During use, please check whether the Power Cord sheath is damaged, improperly bent or stretched, or pressed and deformed by heavy objects. Damage to the Power Cord may result in poor insulation, which is the cause of electric shocks and fires. If the Power Cord is damaged, it must be replaced by professionals of the manufacturer or its repair department or a similar department in order to avoid danger.  <p>Prohibitions</p>	<p>Unauthorized modification or repair is prohibited.</p> <ul style="list-style-type: none"> •Unless conducted by the maintenance department designated by the company, any unauthorized modification or repair is prohibited to prevent the risk of fires or electric shocks.  <p>Do not disassemble the Machine.</p>
<p>Do not wash any water-repellent or non-water-absorbing laundry in the Washing Machine</p> <ul style="list-style-type: none"> •to prevent abnormal vibration from occurring during washing or spin-drying. (such as raincoats, car covers)  <p>Prohibitions</p>	<p>Cautions when Checking the Running Washing Machine.</p> <ul style="list-style-type: none"> •When a woman or a long-haired person checks the running Washing Machine, please be careful not to let the hair fall into a gap so as to avoid the risk of hair being caught.  <p>Advisory</p>

Precautions





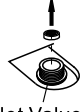

⚠ Caution

<p>Pay attention to spillage.</p> <ul style="list-style-type: none"> •Do not wash water-repellent clothing so as to avoid damage caused by spillage during spin-drying.  <p>Advisory</p>	<p>Caution: Do not place your finger or any object on the curved section of the Washer Lid center or the area on the Panel Frame and over the Washer Lid.</p> <ul style="list-style-type: none"> •This is a cause of injury or malfunction.  <p>Advisory</p>
<p>Do not connect it with a hot water source</p> <ul style="list-style-type: none"> •Hot water can deform plastic parts, which is a cause of malfunctions.  <p>Prohibitions</p>	<p>Do not wash the parts of the main body of the washing machine directly with water</p> <ul style="list-style-type: none"> •so as to avoid poor insulation, which will result in the risk of electric shock.  <p>Prohibitions</p>
<p>Do not attempt to touch internal moving parts while the Washing Machine is running</p> <ul style="list-style-type: none"> •so as to avoid the risk of injury.  <p>Do Not Touch</p>	<p>Do not place a toddler or heavy object on the Washing Machine</p> <ul style="list-style-type: none"> •so as to avoid parts deformation or damage leading to any danger.  <p>Prohibitions</p>
<p>Do not plug or unplug the Power Cord Plug with wet hands</p> <ul style="list-style-type: none"> •so as to avoid the risk of electric shock.  <p>Wet Hands Prohibited</p>	<p>When the Washing Machine is not Used:</p> <ul style="list-style-type: none"> •turn off the Faucet to avoid damage to or falling off of the Water Inlet Hose leading to water leakage; •Unplug the Power cord to prevent fires or other accidents.  <p>Unplug the Plug</p>

Notes on Maintenance

<p>Use a soft cloth to wipe water and dirt on the Housing</p> <ul style="list-style-type: none"> •Do not pour water directly on the Housing. This may result in a short circuit or electric shock. •Do not use a brush, polish, gasoline or other volatile materials to wipe the Washing Machine. This may damage the Main Body Surface Coating or plastic parts. You can choose to retain or tear off the Transport Protection Film on the Housing Surface, which will not influence the normal use of the product. 
<p>Cleaning of the Water Inlet Valve (recommended once every half yearly)</p> <ul style="list-style-type: none"> •Dirt deposits will influence the Water Inlet Volume. Please remove the lint Hose, remove the Lint Filter of the Inlet Valve, and remove the dirt on the lint before re-installing it.  <p>Water Inlet Valve</p>
<p>Cleaning of the Lint Filter (clean it each time after it is used)</p> <ul style="list-style-type: none"> •Remove the Lint Filter. •Remove large lint and brush fine lint from the Lint Filter. Reinstall the Lint Filter. During the installation, snap the frame claws into the bottom groove. (The Lint Filter is a wearing part) 

Packing Instructions

Washing Machine (1)	Manual (1)	Drain Hose Assembly (1)	Water Inlet Hose Assembly (1)	Rat Guard (1)	Screw (1)	Warranty Card (1)
						

Parts Names

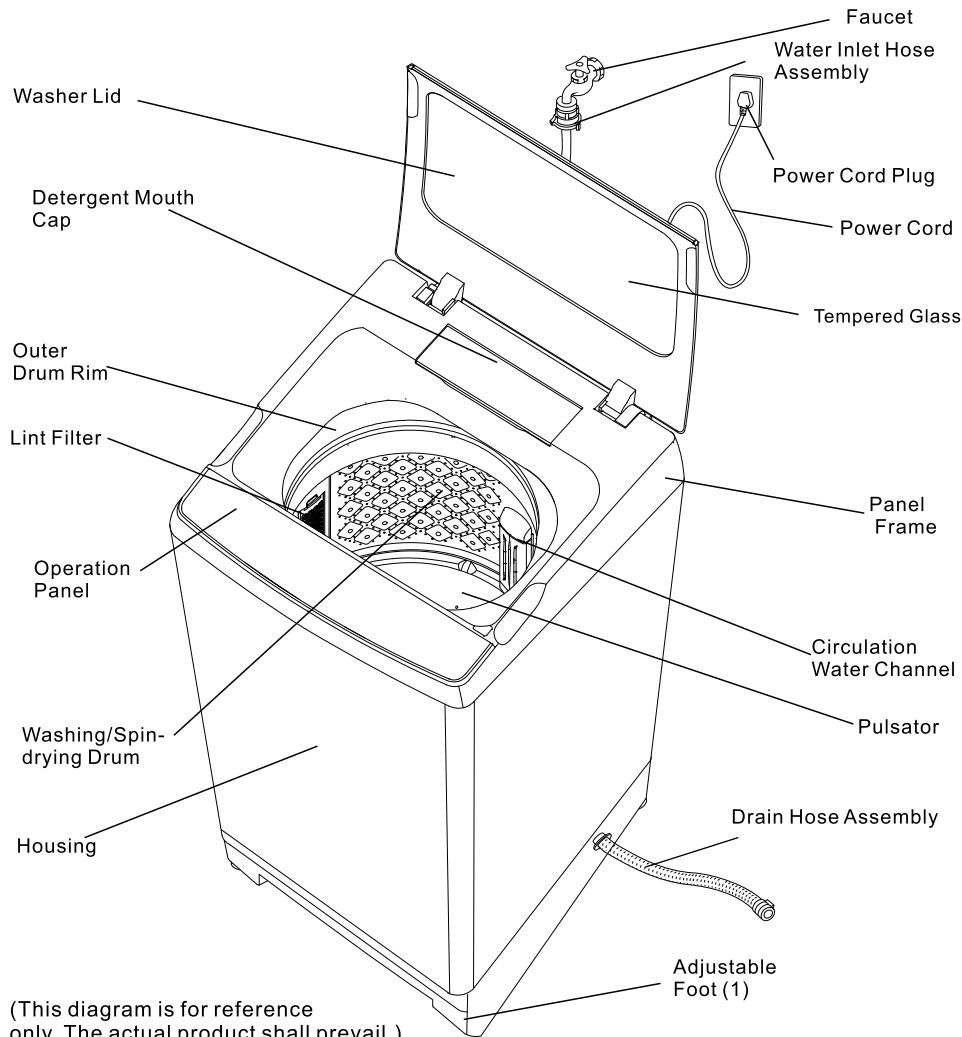

(This diagram is for reference only. The actual product shall prevail.)

Installation Instructions

Shield Installation

1. Take out the Shield on the Panel Frame protective packaging and the Screws in the bag.
2. Tilt the Washing Machine backward and slowly put it down on a cushion.
3. Push the Shield straight along the Seat Slot until it is installed in place.
4. Fix the Shield and Seat with Screws.
5. Lift the Washing Machine gently until it is placed steadily.

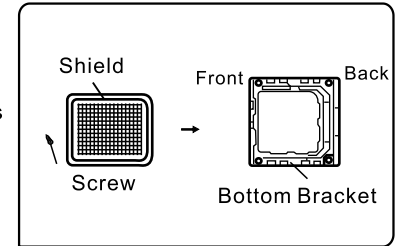

Placement of the Washing Machine

1. Choose a dry place without direct sunlight to the Washing Machine.
2. Place the Washing Machine on steady solid ground.
3. The washing machine should be placed where there is a suitable drainage and can drain water smoothly. The drainage shall be on the same plane that the machine is placed on or slightly lower than the plane, to avoid Washing Machine leakage causing any damage.
4. Place the Washing Machine as firmly as possible. If necessary, level the Washing Machine by adjusting the Adjustable Feet of the Washing Machine according to the order shown in the figures. The maximum allowable inclination of the plane on which the Washing Machine is placed is 2°.

Notes:

- When the Washing Machine is placed on the floor or a flexible support stand, the Washing Machine may vibrate.
- Do not place any object such as a carpet below the Washing Machine to prevent the bottom opening from being blocked.

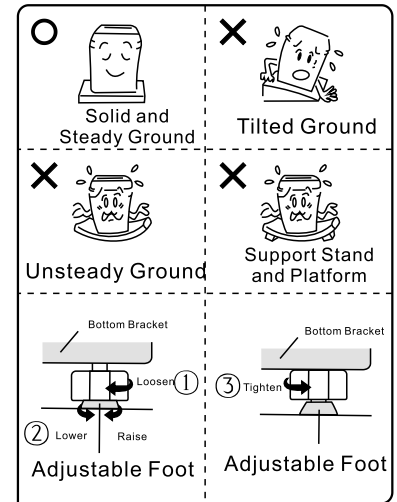

Faucet Selection

Faucet Type: (the faucet mouth shall be smooth)

Type A: The most appropriate

Type B: Faucet length must be greater than 16mm. Otherwise the universal joint cannot be installed.

Type C: Water leakage may occur with the part shown in the figure.

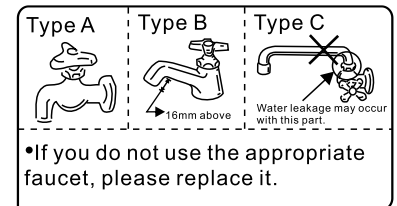

• If you do not use the appropriate faucet, please replace it.

Notes:

1. When installing the Washing Machine, please be sure to remove the Pedestal and Bracket for transportation at the bottom of the Washing Machine. Otherwise it cannot be used.
2. During installation or initial use, a small amount of water will flow out of the Drain Hose, which is residual water left over from the factory during routine inspection.
3. Unplug the Power Cord when Washing Machine is not in use and turn off the faucet to avoid accidental fires and water leakage accidents.

Installation Instructions

Installation of the Universal Joint

1. Hold the Universal Joint in one hand and the Locking Rod in the other hand and then detach the Universal Joint from the Water Inlet Hose.
2. Evenly adjust the four screws on the Universal Joint so that the two screws near the wall fully contact the outside of the Faucet first.
3. Insert the Universal Joint vertically onto the Faucet with its internal seal tightly attaching to the opening of the Faucet and tighten the 4 screws with a screwdriver.
4. Remove the seal from the Universal Joint and tighten the Universal Joint.

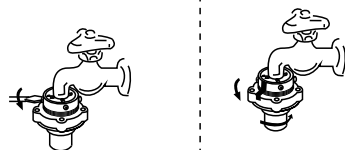
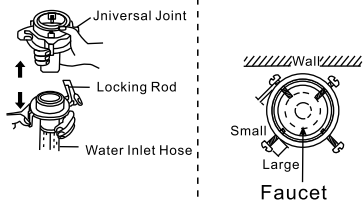

Connection of the Water Inlet Hose

1. Connect the Water Inlet Hose to the Universal Joint.
2. Align the Water Inlet Hose with the opening of the Water Inlet Valve, and turn the fastening screw nut clockwise on the Water Inlet Hose until it cannot be turned any more.
3. Check whether the Water Inlet Hose is Connected Firmly
 - Pull the Water Inlet Hose downwards to check whether the Water Inlet Hose is firmly connected to the Universal Joint. Then slowly turn on the Faucet to see if water leakage occurs. If water leakage occurs, turn off the Faucet and reinstall.
 - After long-term use, the Universal Joint may become loose. Reinstall it.
 - Turn off the Faucet when the laundry Program ends or the Machine will not be used for a long time.

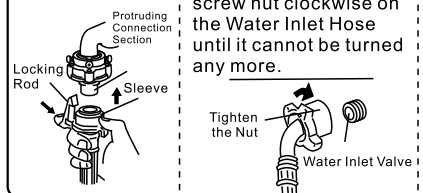

Removal of the Water Inlet Hose

1. Turn off the Faucet.
2. Press the Power Button to turn on the power. Then press the Start/Pause Button.
3. Turn off the power after 15 seconds.
4. Pull down the Locking Rod and Sleeve with your fingers and remove the Water Inlet Hose.
5. Turn the Water Inlet Hose on the Inlet Valve anticlockwise until the Water Inlet Hose is removed.

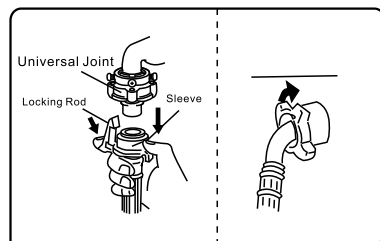

Connection of the Drain Hose

Connect the Drain Hose to the Drain Mouth and then fix it with a hose clamp as shown in the figure on the right:

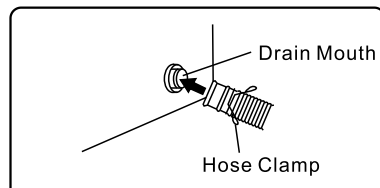

Note: Be sure to use the new Water Inlet Hose included in the accessories instead of an old Water Inlet Hose.

Installation Instructions

Changing of the Position of the Drain Hose

Depending on the use location, the Drain Hose can be changed from being on the right side to being on the left side.

• During the changing, unplug the Power Cord.

• To prevent hand scratches or injuries, please wear gloves.

1. Remove the cap on the Drain Mouth on the left.
2. Lay the Washing Machine backward down on a soft cushion.
3. Loosen the Hose Clamp and unplug the Inner Drain Pipe from the Drain Valve.
4. Push the joint on the Drain Mouth and pull the Inner Drain Pipe out of the Drain Mouth on the right side of the Washing Machine.
5. Insert the Inner Drain Pipe from the Drain Mouth on the left side and snap the joint.
6. Connect the Inner Drain Pipe to the Drain Valve and fix it with the Hose Clamp.
7. Install the Drain Mouth Cap on the left in the appropriate position on the right.
8. Lift the Washing Machine gently until it is placed steadily.

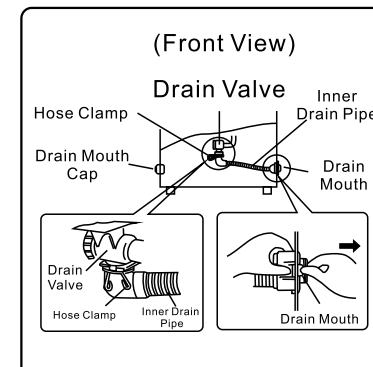

Extension of the Drain Hose

If the drain hose length is not sufficient, please purchase more Drain Hoses from the seller or the company and then connect the Drain Hoses to each other.

Extension of the Drain Hose	Extension Height	Extension Length	
There is a step in the middle	Within 15cm	Within 1cm	
There are no steps in the middle	—	Within 3cm	

Washing Tips

• Please wash colored and white, thick and thin laundry separately. Please wash laundry according to the clothing care tags.

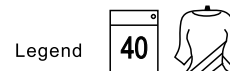

• Please wipe dirt and sand off the laundry first.
• Make sure there are no items in the clothing pockets. (such as nails, coins, etc. that may damage clothes, create abnormal sounds or cause a malfunction of the washing machine.)



• Please put clothes that can easily float, or large, heavy clothes in first.
• If any clothes come to the surface, please temporarily stop washing and press the clothes down into the water. (A pressing plate needs to be placed on the clothes)



• Tighten loose straps on the clothes, ensure zippers and buttons are done up.

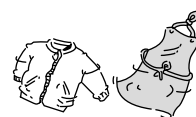

• When washing fine fabrics such as lingerie, lace-trimmed items, nylon and thin chemical fiber fabrics, etc., they should be placed in a mesh washing bag.

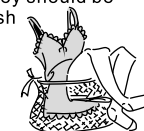

• For the clothes that lose their wool or thread easily, please turn them inside out during washing.



Description of Operation Panel Functions

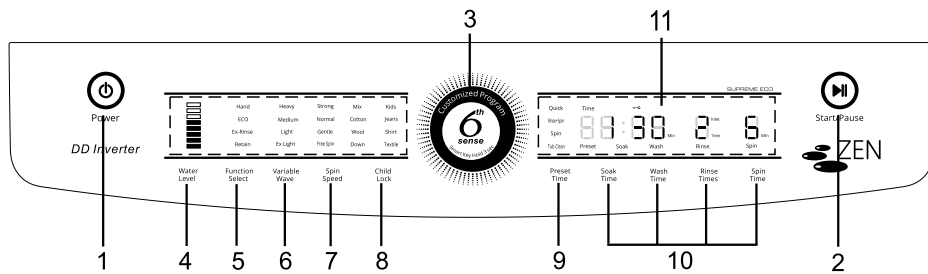

1.Power Button

•To turn on the Washing Machine, please press this Button. To cut off the power, press the Button again. After this Button is pressed, if no other Buttons are pressed within 10 minutes, the power will be cut off automatically. After the program stops running, the power will be cut off automatically within 5 seconds (within 10 minutes if the Draining Function is enabled).

2.Start/Pause Button

•When the power is turned on, the Washing Machine will start running after this Button is pressed. This Button can also be used to temporarily stop the operation. You can just press this Button again to resume the operation.

3.6 Sense Button

•In the Idle State, after the Power Button is pressed, you can press the 6th Sense Button to switch between 12 Automatic Programs - Mix, Cotton, Wool, Down, Kids, Jeans, Shirts, Textile, Quick, Rinse+Spin, Spin and Tub Clean.
 •In the Idle State, you can start the 6 Sense Smart Wash Program by pressing and holding the 6 Sense Button for three seconds.

Note: If you select the Mix, Cotton, Kids, Jeans, Shirts, Quick Program, the Washing Machine will carry out automatic fuzzy judgment to automatically select the appropriate water level, water flow and other procedures.

4.Water Level Button

•This Button is used to select the water level appropriate for the laundry to be washed. Washing and rinsing can be done at different water levels. Only Levels 5 to 8 can be chosen for the Textiles Program. Only Levels 3 to 8 can be chosen for the Wool Program. Only Levels 6 to 8 can be chosen for the Down Program.

5.Function Button

•You can use this Button to switch between the Specialized Programs: Hand (Wash), Eco, Extra Rinse and Retain (Water) functions.

6.Variable Wave Button

•Use this Button to select the washing or rinsing strength according to the degree of dirt of the laundry.

Description of Operation Panel Functions

7.Spin speed Button

•You can use this Button to choose any of the four spin-drying speeds - Strong, Normal, Gentle, Free-Spin.

8.Child Lock Button

•This Button can be used to set the Child Lock Function. See Page 20 for the method for setting the Child Lock Function.

9.Preset Time Button

•You can use this Button to set the end time of the Program.

Note: This function is unavailable for the 6 Sense, Wool, Down, Rinse+Spin, Spin and Tub Clean.

10.Procedure Buttons

•You can use this group of Buttons to set the Soak Time, Wash Time, Rinse Times and Spin Time freely.

11.Description of Digital Display Functions

•Displays the remaining time during operation. For example: Remaining Time: 20 minutes ----- **00:20**

•Displays when will the Scheduled/ Preset Program ends during Preset Time Setting.

For example: Ends in 2 hours: ----- **02:00** Preset Time will blink

•Displays the Fault Code when an abnormality occurs.

For example: Failed to Add Water: ----- **E1**

Quick Start

1. Get Ready

- ① Connect and lay down the Drain Hose.
- ② Connect the Water Inlet Hose to the Faucet and unscrew the Faucet.
 - Before turning on the Faucet, you need to make sure that the screws of the Universal Joint have been tightened. Loose screws may cause water leakage.
- ③ Plug the Power Plug into a power socket.
- ④ Add the laundry.

2. Before a wash starts, add some liquid detergent, powder detergent and softener to the corresponding Boxes. The addition method is as follows:

• Powder Detergent

- Addition Mouth:
- ① Add the appropriate amount of powder detergent according to the laundry amount, water level and soil level based on instructions provided for the usage of the powder detergent.
 - ② For the Fuzzy Program or a Scheduled Wash, it is recommended to add powder detergent directly to the Powder Detergent Box.
 - ③ It is recommended not to use high foam powder detergent to prevent the laundry from being compromised or bubbles from spilling out.
 - ④ Powder detergent of poor quality or powder detergent that has been stored for a long time may cake. Please be sure to clean the powder detergent box regularly.

• Liquid Detergent Addition Mouth: Pour the liquid detergent into the Washing Machine through this mouth. Do not pour beyond the Max mark indicated.

• Softener Addition Mouth: Pour the softener into the Washing Machine through this mouth. The maximum addition amount each time is that indicated by the MAX Mark.

3. Press the Power Button.

4. Press the Start/Pause Button

• The Sensor will automatically detect the clothing amount. (For the 6th Sense, Mix, Cotton, Kids, Jeans, Shirts and Quick Programs.)

• The appropriate water level, water flow and other operating Programs will be selected automatically. Close the Washer Lid.

If the Washer Lid is not closed, the Washing Machine will automatically stop running and emit alarming beeps before it starts spin-drying.

Quick Start

Model	WVTD1050AHG/WVTD1050BHG							
Water Level	1	2	3	4	5	6	7	8
Water Volume (L)	About 16	About 24	About 32	About 40	About 48	About 56	About 64	About 75

- During fuzzy judgment of the water level, there will be some differences due to the laundry texture, size and so on. This is a normal phenomenon.

Program Customization

1. Preparation: Lay down the Drain Hose. Turn on the Faucet. Plug the Power Cord Plug into the power socket. Add the laundry.
2. Press the Power Button.
3. According to the laundry type, press the 6th Sense Button to set the desired Program.

- See the table below for the selection of each Program.

Program Selection Guide			Default Program Settings		
Program	Suitable for daily worn clothes	Laundry Amount	Washing Time	Rinse Method	Spin Time
6 th sense	Suitable for washing of daily worn clothes	4.5kg	10 minutes	Soak Rinse Twice	5 minutes
Mix	Suitable for cotton or chemical fiber fabrics	4.5kg	10 minutes	Soak Rinse Twice	5 minutes
Cotton	Suitable for washing cotton or linen clothes	Rated Laundry Amount	10 minutes	Soak Rinse Twice	5 minutes
Wool	Suitable for delicate fabrics with wool materials	1.5kg	6 minutes	Soak Rinse Twice	2 minutes
Down	Suitable For wash of down jacket	2.0kg	25 minutes	Soak Rinse Twice	5 minutes
Kids	Suitable for washing childrens clothes	5.0kg	15 minutes	Soak Rinse Three Times	5 minutes
Jeans	Suitable for washing jeans	4.0kg	15 minutes	Soak Rinse Twice	5 minutes
Shirts	Suitable for non-ironed shirts or blouses made of cotton, linen or synthetic materials	3.0kg	15 minutes	Soak Rinse Twice	3 minutes
Textile	Suitable for washing large household textiles	6.0kg	12 minutes	Soak Rinse Twice	8 minutes
Quick	Suitable for lightly soiled clothes	3.0kg	5 minutes	Soak Rinse Once	3 minutes
Rinse+ Spin	Used for laundry to be only rinsed and spin-dried	6.0kg	-	Soak Rinse Once	5 minutes
Spin	To spin laundry and drain water in drum	6.0kg	-	-	5 minutes
Tub clean	Only suitable For cleaning the drum	-	85 minutes	Spill Rinse Once	3 minutes

The programme used for the evaluation of models under the mandatory Water Efficiency Labelling Scheme (WELS) and the recommended Washing Programme for soiled clothes is as follows: Cotton+ Highest water level

Program Customization

4. You can press the Preset Time Button and a group of Buttons under the Procedure Button to freely set the preset time, soak time, rinse times and spin time. Once activated, the Digital Display will show numbers cyclically:

As follows:

• Soak Time Options Displayed:

20→30→40→0→10 minutes (unavailable for the 6th Sense, Wool, Down, Jeans, Quick, Rinse+Spin, Spin and Tub Clean Programs)

• Wash Time Options Displayed:

0→1→2→.....→9→10→.....→20 minutes (unavailable for the 6th Sense, Down, Rinse+Spin, Spin and Tub Clean Programs)

0→1→2→.....→9→15 minutes (for the Quick, wool Program only)

• Rinse Times and Method Options Displayed:

0→1→2→3→4 (except for the 6th Sense, Spin and Tub Clean Programs)

0→1→2→3 (for the Quick Program only)

2→3→4 (for the Kid Program only)

Water Spill can be set for the Double Extra Rinse Function only.

• Spin Time Options Displayed:

0→1→2→.....→9 minutes (unavailable for the 6th Sense and Tub Clean Programs)

0→1→2→4→5 minutes (for the Wool, Down, Shirts, and Quick Programs only)

Note: When the Soak Time or Wash Time Button is pressed once, the Digital Display will show the set time as 5 seconds. Press the Soak Time or Wash Time Button again within 5 seconds to adjust the soaking time and washing time, where the displayed time will be increased by 5 seconds. If the Soak Time or Wash Time Button is not pressed within 5 seconds, the Digital Display will show the remaining time again (the above settings are unavailable for some Programs).

5. Press the Water Level Button to select the appropriate level. Add some detergent.

6. Press the Start/Pause Button

7. Close the washer lid.

8. Press the Function Button to enable your desired additional functions, which can be the Hand (wash), Eco, Extra Rinse, or Retain (water) Function.

• Hand (wash): When function is selected, there will be 4 kinds of water current for washing. This function requires a washing load less than or equal to 3kg and is only available for the Mix, Jeans, Cotton, Kids, Shirts, Textile Programs. When function is enabled, the Indicator of this function will be lit. Water Level Button and Wash Time Button will be disabled.

• Eco: After this function is enabled, the corresponding Indicator will be lit and the Washing Mode will be changed to the Eco Mode. This function is available for the Mix, Cotton, Kids, Jeans, Shirts and Textile Programs only.

• Extra Rinse: This will be a 2 step procedure. Firstly, water will be added into the tub and the drum will spin at a low speed. Water will be drained out simultaneously. After the first step, water will stop draining out and be retained in the tub and more water will flow in while the rinse continues. Once this function is enabled, the corresponding indicator will lit up. This function is available for the Mix, Cotton, Kids, Jeans, Shirts, Textile and Rinse+Spin programs only.

• Retain (Water): Once activated, machine will pause between final draining and spin drying and no water will be drained until consumer presses the start button. The purpose is for consumer to recycle water from the last rinse. After this function is enabled, the Indicator will blink accompanied by beeps every 10 minutes. The Spin Procedure will restore when you press the Start Button. If there is no operation within 1 hour, the power will be cut off automatically. (This function is unavailable for the 6th Sense, Spin, and Tub Clean program.)

Textiles Program Instructions

The Textile Program applies to washing blankets and other large items

• When this Program is used, the water level is automatically set to Level 8.

However, you can change the water level to Levels 5 ~ 8 according to the size of the household textiles.

Operation Steps

1. Open the Washer Lid and press the Power Button.
 2. Press the 6th Sense Button until the Textile Indicator is lit.
 3. Pour the liquid detergent into the Detergent Box. If you are using powder detergent, dissolve it thoroughly in 5L of warm water (about 30°C) and then slowly pour the solution into the Washing Machine.
 4. Place the rolled side of the household textile down in the Washing Machine.
 5. Press the Start/Pause Button (If necessary, you can adjust the water level manually.)
 6. Close the Washer Lid.
- If the washer lid is not closed properly, the Washing Machine will automatically stop running before starting spin cycle.
 - After the wash ends, the beeper will emit beeps and then the power will be cut off automatically within 5 seconds.
 - After the wash ends, turn off the Faucet and clean the Mesh Lint Pouch.

How to Fold a Blanket and Put it in the Washing Machine

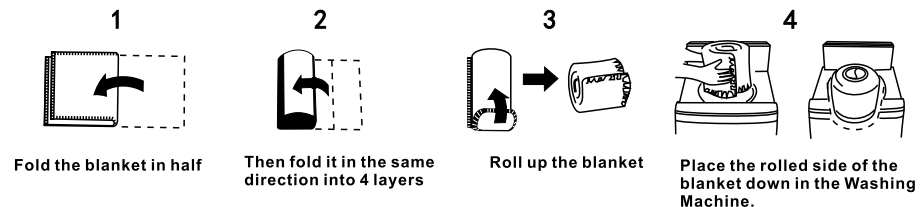

After the wash ends

Take out the blanket and hang it from the middle in the shade.

Note:

- Pre-wash the dirty parts by hand.
- Do not use too much detergent.
- Stains can be removed effectively with warm water (about 30°C).
- During the washing process, if a part of the blanket is exposed above the water surface, press the Start/Pause Button. The Washing Machine will temporarily stop running. Press the exposed part into the water and press the Start/Pause Button again to resume the wash.

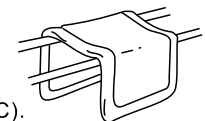

Wool Program Instructions

- This Program is used for washing wool clothes. Please check the clothing care tag before starting the wash.
- When the Wool Program is used, the water level is automatically set to Level 6. However, you can change the water level to Level 3 ~ 8 according to the size of the wool clothes.

Operation Steps

1. Open the Washer Lid and press the Power Button.
 2. Press the 6th Sense Button until the Wool Indicator is lit.
 3. Pour the liquid detergent into the Detergent Box. If you are using powder detergent, dissolve it thoroughly in 5L of warm water (about 30°C) and then slowly pour the solution into the Washing Machine.
 4. Put wool clothes in the Washing Machine.
 5. Press the Start/Pause Button (If necessary, you can adjust the Water Level manually.)
 6. Close the Washer Lid.
- If the Washer Lid is not closed properly, the Washing Machine will automatically stop running before starting spin-drying.
 - After the wash ends, there will be beeps and the power will be cut off automatically within 5 seconds.
 - After the wash ends, turn off the Faucet and clean the Mesh Lint Filter Pouch.

Caution

- The laundry amount shall be less than 1.5kg.
- After the program ends, please remove the clothes immediately and air them to prevent deforming due to prolonged placement in the washer.
- The Wool Program cannot be scheduled.
- In order to avoid damage to the clothes, the temperature of the washing water shall not exceed 30°C.
- Please wash clothes of white or bright colors and the clothes of dark colors separately. Using dedicated wool detergents can reduce the damage to clothes and improve the washing effect.

Description of other Functions, Method for Setting These Functions

Preset Time/ Schedule Function

- The Pre-set Schedule Time is the Program end time.
- Before making a Schedule, first turn on the Faucet, and then lay down the Drain Hose and check whether the Universal Joint is tightened to avoid water leakage accidents.

Operation Steps

1. Close the Washer Lid. Press the Power Button.
2. Put the laundry into the drum.
3. Choose the appropriate Program, procedures and water level needed.
4. Press the Preset Time Button to set the schedule time.

•Preset Time Options Displayed: 6 → 7 → 8 → ... → 24 → 0 → 1 ... → 5 (hours)

5. Add some detergent and close the washer lid.
- Detergent Addition for a Preset wash: Add detergent, powder detergent and softener to the corresponding Boxes. When liquid detergent is used, please dilute it with water of 2 times the volume of the detergent to be used and then pour the diluted detergent into the Detergent Box.
6. Press the Start/Pause Button
 7. Close the washer lid.
- All the indicators except the Preset Time Indicator and the 6TH Sense Smart Slider indicator will go out in about one minute. (If the Child Lock is enabled, the Child Lock Indicator will be lit)
 - This function is unavailable for the 6th Sense, Wool, Down, Rinse+Spin, Spin and Tub Clean Programs.
 - If you want to check the Preset/ Scheduled Program, please press any Button other than the Power Button. Then the Preset/ Scheduled Program will be displayed for 5 seconds.
 - To change the Preset/ Scheduled Program, turn off the power and then restart the Machine and carry out the resetting.
 - The Preset Time Program will be disabled if the Power Cord Plug is unplugged or a power failure occurs.

Smart Memory Function

If you choose the Mix or Cotton Program, the Washing Machine will remember your choice after the Program ends. When you use the Machine the next time, the remembered Program will be displayed after you turn on the power. The Machine will start running when you simply press the Start/Pause Button.

- For the Mix or Cotton Program, no wash parameters but only the Program will be remembered.

Two-step Clean Function

During the washing process, after the water level of the washing machine reaches the level that is two levels lower than the pre-set water level, the wash will start while water continues to flow in.

- When the two lowest levels are set, the wash will start after the pre-set water levels are reached.
- The Two-step Clean Function is unavailable for the Wool, Textile, Rinse+Spin and Spin Programs.
- If the Soak Time Procedure is selected, after the soak ends, the Two-step Clean Function will be disabled during the wash.

Description of other Functions, Method for Setting These Functions

Variable Wave Function

After this function is enabled, the washing or rinsing strength can be changed. This function can be enabled before a Program starts or while a Program is running.

Water Level (Varied Wash) Function

In order to improve the detergent content in the washing water and save water, you can set different water levels for a wash and rinse respectively. It is recommended that the wash proceeds at a lower water level and the rinse at a higher water level. In this way, a clean wash and a thorough rinse can be ensured.

Setting Method

Press the Power Button to turn on the power. After selecting the appropriate Program, press the Wash Button to set the washing time, press the Water Level Button to set the wash water level, press the Rinse Button to set the rinsing times, press the Water Level Button again to set the rinsing water level, press the Spin Button to set the spin-drying time, and finally, press the Start/Pause Button to start. Then the wash and rinse will proceed at different pre-set water levels.

Residual Water Draining Function

After it is enabled, within 9 minutes after the Program ends, the Drain Valve will open automatically to drain the remaining water inside the Machine. To prevent it from becoming frozen when the weather turns cold. (Used when the temperature is below 0°C)

Setting Method

•Press the Power Button. Press and hold the Spin Time Button for more than 4 seconds until you hear a beep. Repeat the operation to enable beeps.

Tub Light Function

The washer lid is opened and will go out 2 minutes after the washer lid is closed. The Tub Light Function will go out automatically 3 minutes after the washer lid is not closed.

Soak Function

After the Soak Function is enabled, a dynamic soak can be added before a wash (this function is unavailable for the 6th Sense, Wool, Down, Jeans, Quick, Rinse+Spin, Spin and Tub Clean Programs) The soaking time is 0 - 40 minutes with an increment of 10 minutes.

Energy-saving Function

This function is enabled by default in the factory settings. Once enabled, the backlight will automatically go off after 30 seconds of inactivity upon switching on the machine. All the indicators except the 6th Sense Smart Slider and Child Lock indicator will go out and be locked. If a program has been chosen, the backlight of the programs will stay lit for 10 seconds and automatically go off after. When any button other than the Power Button is pressed and held for 2 seconds, you will hear a beep, and the Backlight will be turned on and the Buttons will be unlocked. Press and hold the Wash Button for 4 seconds until you hear a beep, and the Automatic Button Lock Function will be enabled. When you want to disable the function, repeat the above steps until you hear a beep, and the function will be disabled.

Description of other Functions, Method for Setting These Functions

Program Midway Change Function

This is a function that can change the parameters of a procedure that has not been performed after a wash starts. Procedures that are being performed and has already been performed cannot be changed. The Preset Time Procedure cannot be changed.

While the Machine is running, you can adjust the rinse and spin parameters and press the Wash Time and Spin Time Buttons, and the Digital Display will show the corresponding content.

Child Lock Function

You can enable the Child Lock Function to avoid injury to a child opening the washer lid of the Washing Machine.

Setting Method

Press the Power Button to turn on the power. Press and hold the Child Lock Button for more than 3 seconds until you hear a beep. Repeat the operation to enable it again.

•After the Child Lock is enabled, the Washing Machine will stop running and display “**ES**” and emit alarming beeps when the washer lid is opened for more than 5 seconds during a wash.

•After the Child Lock is enabled, while a Program is running, no Buttons except the Power Button will respond.

Disabling Beeps

Cancel Method: Press the Power Button. Press and hold the Start/Pause Button for more than 4 seconds until you hear a beep. Repeat the operation to enable beeps.

Troubleshooting Guide

When any of the following problems occurs, the Smart Microcontroller will detect the abnormal status and emit alarming beeps for about 10 seconds, and the Digital Display will display the following in the Table below.

Notes:

After all the items are checked and addressed, press the Start/Pause Button. If no fault is displayed, the Washing Machine will resume its running. If there is still any abnormality, please unplug the Power Cord and call the company's Customer Service number as soon as possible.

Fault Type	Fault Displayed	Cause
The washer does not work at all		<ul style="list-style-type: none"> •Is the power connected? •Has the Start/Pause Button been pressed? •Is it in a Schedule State? •Is the power fuse or current circuit breaker intact? •Is there a power failure?
Water does not flow into the drum	E 1	<ul style="list-style-type: none"> •Is the Faucet turned on? •Is the Water Inlet Hose or the Screen Lint Filter of the Water Inlet Valve blocked? •Is the water pressure too small and the water addition time too long?
Water does not drain out	E 2	<ul style="list-style-type: none"> •Is the Drain Hose laid down? •Is the Drain Mouth in a too high position (of more than 15cm)? •Is the Drain Mouth blocked?
Washer does not spin	E 3	<ul style="list-style-type: none"> •Is the laundry mostly on one side of the Washing/Spin-drying Drum? •Is the Washing Machine placed flatly?
	E 4	Is the washer lid open?
Wash Failure	E 5	<ul style="list-style-type: none"> •Is the Child Lock Function enabled? •Is the washer lid open?
Others	E A E 6 E C	<ul style="list-style-type: none"> •Please press the Power Button to turn off the power, unplug the Power Cord Plug, and call the company's Customer Service number as soon as possible.
	E 90 E 902 E 920 etc.	
	E d	

Non-malfunction Cases

- 1.Sometimes water is added during a wash or rinse. This is automatic water replenishment due to a lowered water level.
- 2.At the beginning of Spin-drying, the drum will stop and start intermittently. This is intermittent Spin-drying designed to achieve a better Spin-drying effect.
- 3.During the Spill Rinse, the Drain Hose does not drain water. This is due to the set water level being too low or the water pressure being too low.
- 4.Sometimes water is replenished during Spin-drying. This is an automatic replenishment due to the improper placement of the laundry to be Spin-dried.
- 5.After the Spin-drying ends, there is the sound of residual water, which is the sound of the balance liquid that is in the balance ring and designed to reduce Spin-drying vibration.
- 6.There was a power failure during operation and the operation cannot be automatically resumed after the power supply restores. Please set the Machine again.