

Register your product online

網上登記新產品保養

For Singapore Warranty, please scan QR code or visit below website:



<https://www.whirlpool.com.sg/warranty-registration.php>

Whirlpool

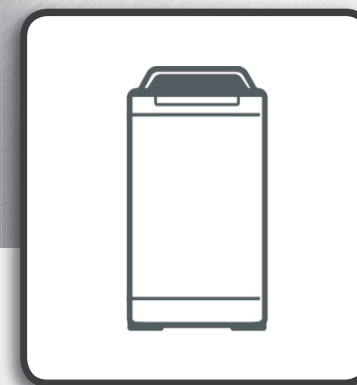

Health & Safety, Use & Care, Installation Guide

Models:

VWVC10512GS

VWVD9512GG

VWVD10512GG

- Please read this manual carefully before using this machine, and please keep it in a safe place.
- When the washing machine is not in use, the water tap must be turned off and the power cord must be unplugged.
- This machine is manufactured with reusable materials. Please assist in proper disposal or recycling when disposing to protect the environment.
- This machine may be subjected to changes in structure and performance parameters in the future without prior notice.

USER MANUAL



THANK YOU FOR BUYING A WHIRLPOOL PRODUCT.



Read operator's manual



INDEX

Safety Instructions	2~4
Installation Instructions	5~7
Specifications	7
Product Description	8
Accessories	8
Control Panel	9~10
Program	11
Stain Program	11
Functions & Specials	12~13
General Usage	14
Hints & Tips	15
Cleaning & Maintenance	15
Troubleshooting Guide	16
Non Failure Indications	17









SAFETY INSTRUCTIONS

IMPORTANT TO BE READ AND OBSERVED

- Please read the manual carefully before using this appliance.
- This appliance is not intended to be used by persons with insufficient physical, sensory, or mental function (including children), or those who lack experience and knowledge, unless under the supervision or guidance of a person who can ensure their safety.
- In order to avoid any property damages or personal injuries in usage, the matters that must be observed in terms of safety are explained as below:

 Warning	Misoperation may cause possibility of death or injury.
 Attention	Misoperation may cause possibility of injury and damage to items.

		
This mark here indicates the content of warning or attention.	This mark here indicates the prohibited actions.	Attention

 Warning	
 Modification is not allowed, non-professional maintenance personnel are prohibited to disassemble and repair the washing machine. <ul style="list-style-type: none"> • Can cause fire, electric shock, or injury. • Please contact your dealer or After-sales Service in case of failure. 	 Do not bend, pull, or twist the power cord excessively. <ul style="list-style-type: none"> • It may cause damage to the power cord and may lead to fire or electric shock.
 During maintenance, be sure to unplug the power cord from the socket. In addition, do not plug or unplug the power cord when your hands are wet. <ul style="list-style-type: none"> • It may cause electric shock and injury. 	 Do not use voltage or frequency other than the marked specifications. <ul style="list-style-type: none"> • It may cause damage, fire and electric shock.
 Do not use the power cord and plug when they are damaged or loose. <ul style="list-style-type: none"> • Can cause electric shock, short circuit, injury or fire. 	 Dusts and other dirt on the power cord and plug shall be removed regularly. <ul style="list-style-type: none"> • If dust accumulates on the power cord and plug, it can cause fire due to poor insulation caused by moisture.
 Do not use the washing machine for other purposes. <ul style="list-style-type: none"> • The washing machine shall not be used for any purposes other than washing clothes that can be washed in accordance with the instructions to avoid damage to the washing machine or other possible danger. 	 Do not place on uneven ground. <ul style="list-style-type: none"> • Otherwise machine will be easy to fall and move, causing injuries and damage to the washing machine.

Warning

When the washing machine is running, do not reach into the tub.

- If your hand touches the tub, it may cause injury.
- During spinning, if the tub does not stop rotating within 15 seconds of opening the door, please immediately turn off the power and contact your dealer or After-sales Service.



No touching

Do not wash clothing that has been exposed to volatile solvents.

- Do not wash clothing stained with gasoline, kerosene, thinner, etc. This may cause fire or explosion.



Forbidden

Must be grounded properly.

- The socket should be well grounded
- In order to prevent leakage accidents.



The socket should be well grounded



Avoid installation in wet and rainy places.

- The bad insulation of electrical appliances will cause electric leakage or fault.



Forbidden

Do not let children play on the washing machine or in the tub.

- Serious injuries may occur if children accidentally fall into the wash/spin tub.



Forbidden

Sockets other than specified rating is not allowed to be used.

- It may cause risk of damage, fire and electric shock.
- Please use sockets above 10A alone, do not use extension sockets or share power with other appliances.



Forbidden

Plugging and unplugging of the power cord.

- When plugging or unplugging the power cord hold the insulating part to apply force. Do not touch the metal piece of the plug or apply force to the wire end to avoid electric shock or pull off of inner wire of the power cord.
- Be sure to unplug the power cord before moving the washing machine.



Forbidden

Keep away from fire.

- Keep away from fireworks, and do not place lighted candles, cigarettes, mosquito coils and kettles on washing machines. This is the main cause of fire or deformation.



Forbidden

Protection of the power cord.

- Before using it, please pay attention to whether the outer wrapping of the power cord is damaged, whether it is unreasonably bent or stretched, and whether it is pressed and deformed by weight. Damage of power cord may cause poor insulation. This is the cause of electric shock and fire. If the power cord is damaged, in order to avoid danger, it must be replaced by a professional from the manufacturer, contact your dealer or After-sales Service.



Forbidden

Modification or self repair is not allowed.

- Except for the professional from the manufacturer, it is forbidden to self modify or repair it to avoid the danger of fire or electric shock.



Disassembling Forbidden

Warning

Waterproof or non-absorbent laundry should not be washed in the washing machine.

- To avoid abnormal vibration when washing or dehydrating. (Eg: raincoat, car cover)



Forbidden

Be careful when visiting the washing machine.

- Especially for people with long hair, please be careful not to drop your hair into the gaps to avoid risk of hair being trapped.



Attention

Attention

Watch out for spills of laundry.

- Do not wash clothing that is water-resistant to avoid damage caused by laundry overflow during spinning.



Attention

Do not wash the parts of the washing machine directly with water.

- To avoid the risk of electric shock due to poor insulation.



Forbidden

Do not connect to hot water supply!

- Hot water can deform plastic parts, it is the cause of the malfunction.



Forbidden

Please do not stand on or put weight on the washing machine.

- To avoid danger caused by deformation or damage of components.



Forbidden

Do not attempt to touch the internal moving parts while the washing machine is running.

- To avoid danger of injury.



No touching

When the washing machine is not in use

- The water tap should be closed to prevent the water inlet hose from being damaged or falling off, resulting in a water leakage accident.
- The power cord should be unplugged to prevent fire or other accidents.



Unplug the Power cord

Please do not plug or unplug the power cord when your hands are wet.

- To avoid the danger of electric shock.



Wet and Forbidden

This appliance is intended to be used in household and similar applications such as:

- staff kitchen areas in shops, offices and other working environments;
- farm houses;
- by clients in hotels, motels and other residential type environments;
- bed and breakfast type environments;
- areas for communal use in blocks of flats or in laundrettes.

INSTALLATION INSTRUCTIONS

Transportation

At least two people are needed to carry the machine. One person on one side carries the cabinet handles.

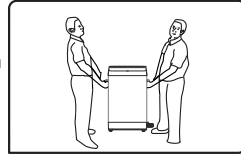

Installation of Bottom Cover

1. Take out the bottom cover on the washing machine surface protection rack and the screws in accessories bag.
2. Tilt the washing machine backwards and slowly lay it down on the cushion.
3. Push the bottom cover straight into the base slot until it is seated in position.
4. Fix the bottom cover to the base with screws.
5. Lift up the washing machine gently and make it stand steady.

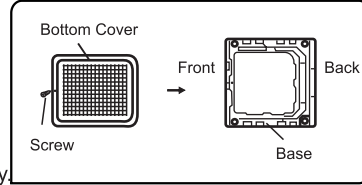

Note: Please be sure to install the bottom cover in place before using.

Location of the washing machine

1. Choose a dry place out of sunlight to place the washing machine.
2. Place the washing machine on a solid, stable floor.
3. The floor where the washing machine is installed should have a floor drain, and the floor drain should be unobstructed. At the same time, the floor drain should be flat with or slightly lower than the surface on which the washing machine is installed to prevent water leakage of the washing machine and cause harm.
4. Make the washing machine stand as stable as possible. If necessary, level the washing machine by adjusting the adjustable feet of the washing machine in the order shown. The maximum allowable inclination of the washing machine placement surface is 2°.
5. Minimum installation distance from the wall or installation cabinet is 10cm.

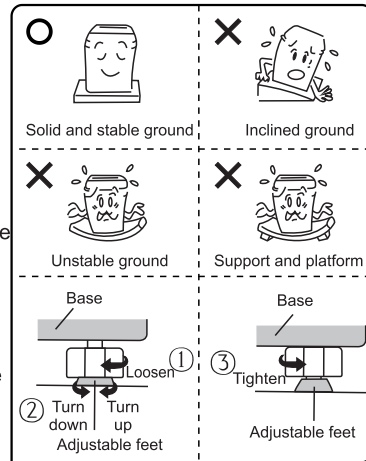

Note:

- When the washing machine is placed on the floor or a flexible support, vibration of the washing machine may be caused.
- Do not place carpets, etc. under the bottom of the washing machine to avoid blocking the bottom area.

Selection of Water Tap

Water Tap type: (the opening of the water tap should be flat)

Type A: Most suitable.

Type B: The water tap length must be greater than 16mm, otherwise the universal joint cannot be installed.

Type C: Water leakage may occur in the area as shown in the figure.

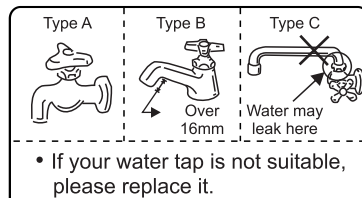

Note:

1. When installing the washing machine, be sure to remove the pedestal and bracket used for transportation at the bottom of the washing machine, otherwise it will not be usable.
2. During installation or initial use, there will be a small amount of water flowing out of the drain hose, which is the residual water left during the routine inspection of the factory.
3. After using the washing machine, please unplug the power cord and turn off the water tap to prevent fire and water leakage.

Installation of Universal Joint

<ol style="list-style-type: none"> 1. Hold the universal joint on one hand and press the locking lever on one hand to separate the universal joint from the water inlet hose. 	<ol style="list-style-type: none"> 2. Adjust the 4 screws on the universal joint evenly, so that the 2 screws on the wall side can fully make contact with the outer part of the water tap first. 	<ol style="list-style-type: none"> 3. Put the universal joint vertically on the water tap, make the inner seal ring close to the opening of the water tap, and tighten the 4 screws with a screwdriver. 	<ol style="list-style-type: none"> 4. Remove the seal from the universal joint and tighten the universal joint.
--	--	--	--

Connection of water inlet hose

<ol style="list-style-type: none"> 1. Connect the water inlet hose to the universal joint. 	<ol style="list-style-type: none"> 2. Align the inlet hose port with the inlet valve port, and turn the tightening nut on the inlet hose clockwise until it stops. 	<ol style="list-style-type: none"> 3. Check whether the water inlet hose is securely connected. <ul style="list-style-type: none"> • Pull the water inlet hose downward to confirm that the water inlet hose is connected to the universal joint reliably, then slowly open the water tap to check water leakage. If water leaks, turn off the water tap and reinstall it. • After long-term use, the universal connector may become loose. In this case, please reinstall it. • Turn off the water tap when the machine is not in use.
---	---	--

Removing the water inlet hose

1. Turn off the water tap.
2. Press the "Power" button to turn ON the power, and press the "Start / Pause" button.
3. Turn off the power after 15 seconds.
4. Press down on the locking lever and sleeve with finger and pull them downward to remove the water inlet hose.
5. Turn the water inlet hose on the water inlet valve counterclockwise until the water inlet hose is removed.

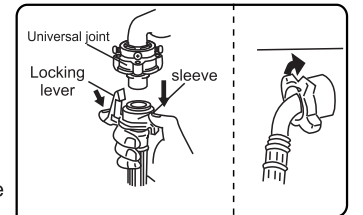

Connection of the drain hose

1. Connect the drain hose to the drainage outlet and secure it with the hose circlip. As shown on the right:

Note: Be sure to use the new water inlet hose in the accessories bag. The old water inlet hose cannot be reused.

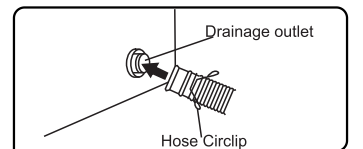

Installation Instructions

Change the direction of the drain hose

The drain hose can be changed from the right to the left according to the needs in use.

- The power cord should be unplugged when replacing.
- Gloves should be worn to prevent hand scratches.

1. Remove the drain cover on the left side.
2. Tilt the washing machine backwards on a soft cushion.
3. Loosen the hose circlip and disconnect the drain hose from the drain valve.
4. Push the connector of the drain port and pull the drain hose out of the washing machine from the right drain port.
5. Insert the drain hose from the drain port on the left, and tighten the joint.
6. Connect the drain hose with the drain valve and fix it with a hose circlip.
7. Install the drain cover on the right side.
8. Lift up the washing machine gently and make it stand steady.

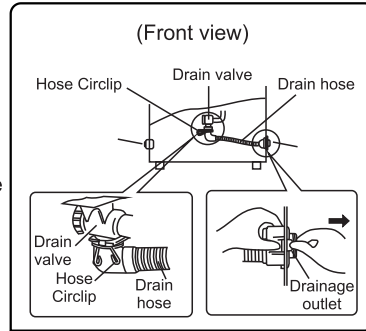

Extension of the drain hose

When the length of the drain hose is not long enough, please purchase an extension hose from your dealer or After-sales Service to connect it.

Extension of the drain hose	Extension height	Extension length
There are steps in between	Within 15cm	Within 1m
There are no steps in between	—	Within 3m

Specifications

Type	VWVD9512GG	VWVC10512GS	VWVD10512GG
Rated washing capacity	9.5kg	10.5kg	10.5kg
Rated spin capacity	9.5kg	10.5kg	10.5kg
Rated voltage and frequency	220~240V 50Hz	220~240V 50Hz	220~240V 50Hz
Rated power	400W	450W	420W
Net weight	34kg	39kg	39kg
Water pressure	0.03~0.8MPa	0.03~0.8MPa	0.03~0.8MPa
Net dimensions (WxDxH)	540x563x940mm	570x592x965mm	570x592x965mm

Product Description

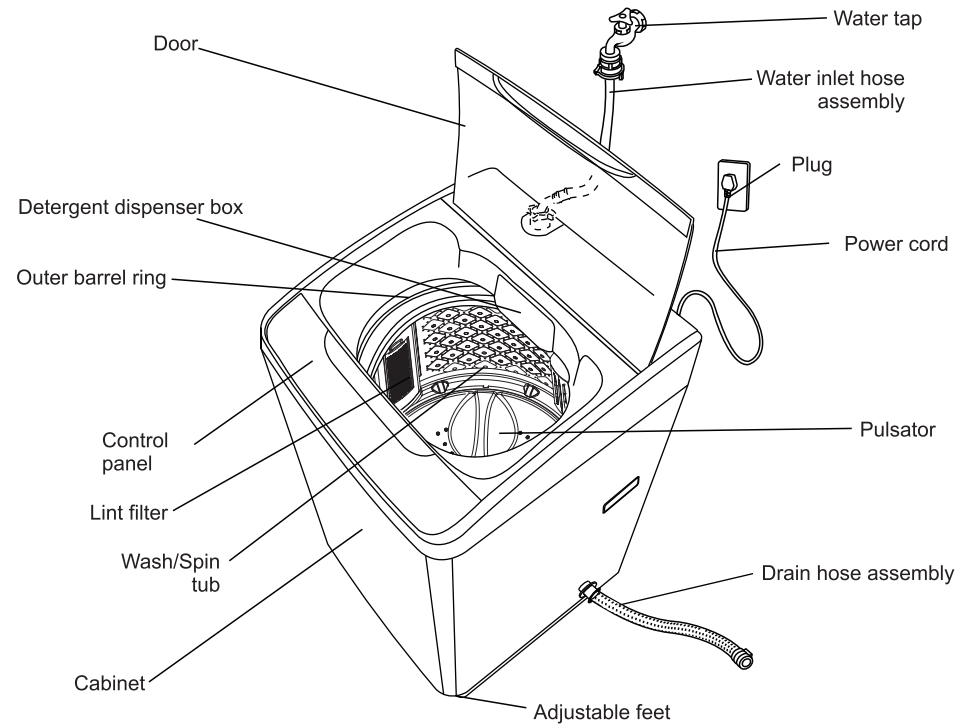

Picture for reference only, please refer to the actual product.

Accessories

Instruction Manual	Drain hose assembly (1pcs)	Water inlet hose assembly (1pcs)	Bottom cover (1pcs)	Screw (One pc.)

Control Panel

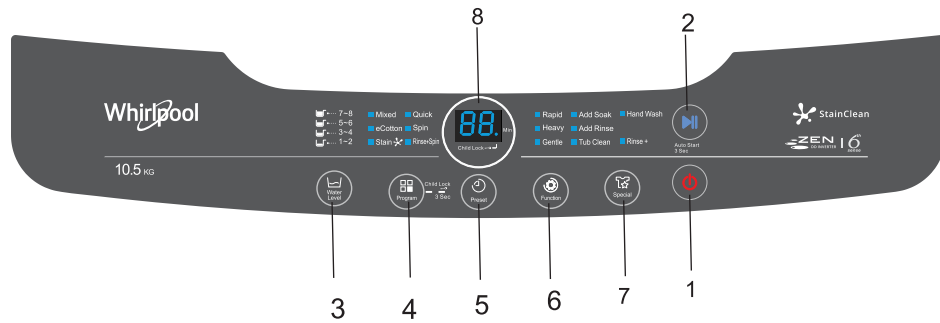

1.Power ON/OFF Button

- Press this button to switch on the washing machine. To switch off the power, press it again. If idle for 10 minutes after machine is turned on, the power will be automatically cut off. After washing program finishes, the power will be cut off automatically after 5 seconds.

2.Start/ Pause Button

- Press this button, to start a washing program machine. Press once to pause the operation, to resume, press the same button again. In shutdown mode, press and hold this button for 3 seconds to auto start a predefined program with setting as: "Mixed" program + "Hand wash" + "Rinse+".

3.Water Level Button

- Press the button to select the suitable water level from 1-8 depending on the load. Water level cannot be selected: for "Tub Clean" and "Spin".

4.Program Button

- Press the button to select the desired washing program. When you select "Mixed", "Quick", "eCotton", "Stain" program, 6th sense fuzzy logic will be applied for auto detections. Press and hold the "Program" button for 3 seconds to set or cancel the child lock function. Please refer to the setting method in "Functions" section.

5.Preset Button

- After power on, press the "Preset" button to set the delay function, and preset the time from the start to end of washing program. Delay time can be set from 1-24 hours.

Control Panel

6.Function Button

- Press the "Function" Button to select desired function. Multiple selections are not allowed and some programs cannot select function.

7. Special Button

- Press the "Special" Button to select between "Hand Wash" and "Rinse +". Multi-selection is possible, some programs cannot select these functions.

8.Digital display window

- The remaining time is displayed during operation. Example: 20 minutes remaining. -----
- Water level is displayed when pressing "Water Level" Button. -----
- When an error occurs, a fault code is displayed. Example: No water intake. -----
- When the child lock is set, the child lock indicator lights up. -----

Program

See the table below for the program selection guide:

Program Selection Guide			
Program	Description	Max Wash Load (Kg)	
		9.5kg capacity	10.5kg capacity
Mixed	Standard program for mixed clothing items, most efficient in terms of water and energy consumption	Rated Laundry Amount	
eCotton	Suitable for cotton washing load	Rated Laundry Amount	
Stain	Used to treat tough stains on soiled clothes, suitable for cotton, linen and synthetic garments**	4	5
Quick	Quick washing of small load or lightly soiled garments	3	3
Spin	Spins the load then empties the water	-	-
Rinse+Spin	For loads that need rinsing and spinning only	-	-

*Due to different conditions such as water pressure, draining, and type of clothing, the actual program running time may be different from the remaining time displayed.

**Washing performance of Stain program dependent on ambient temperature. In order to improve the washing effect, the amount of detergent can be appropriately increased.

Functions & Specials

Preset function

- The delay time is the time from the start to the end of the program.
- Before setting the preset function, first open the water tap, lay down the drain hose, and check whether the universal joint is tightened to prevent water leakage.

How to set Preset function

1. Open the door and press the "Power On / Off" button.
2. Add the laundry into the washing tub.
3. Select the appropriate program, function and water level.
4. Press the "Preset" button to set the delay time.
 - Delay time can be set from 1-24 hours.
5. Add detergent and close the door.
6. Press the "Start/Pause" button.
 - After about one minute, all lights except the program light are off. (If the child lock function is set, the child lock light is on.)
 - To view the selected program, press any button except the "Power On/Off" button. The selected program will be displayed for 5 seconds.
 - To change program, turn off the machine and restart the settings.
 - The preset function will be canceled after unplugging power cord or power failure.

Intelligent memory function

Applicable to "Mixed" program, the washing machine will automatically save the program settings. The next time you use it, turn on the "Power On / Off" and press the "Start / Pause" button. The washing machine will automatically continue the saved settings.

- Functions and water level setting will not be saved

Double-level power wash

In order to increase the concentration of the detergent, during the washing process, when the water reaches two levels lower than the set level, washing will start with water continuous inflowing.

- This function is not applicable to water level 1 or 2.
- This function is not applicable to some programs.
- When the "Add soak" function is selected, after soaking, this function will not take place.

Functions & Specials

Child lock function

Lock the buttons of control panel against improper use (by children) with this function. After the child lock function is turned on, all other buttons will not respond except the "Power On/Off" button.

- How to set: Press the "Power On/Off" button. After turning on the power, press and hold the "Program" button for 3 seconds until you hear a beep sound, the child lock function is activated. To cancel repeat the above steps.

Rapid function

Select "Rapid" function to reduce program run time.
Some programs cannot select this function

Heavy function

Select "Heavy" function to increase washing flow with stronger impeller movements, suitable for bulk load such as duvet or heavily soiled clothes.
Some programs cannot select this function.

Gentle function

Select the "Gentle" function to reduce washing flow, suitable for under garments, silk fabric.

Add Soak function

Select "Add soak" function to add soaking process before washing
Some programs cannot select this function.

Add Rinse function

Select "Add Rinse" function to add one more rinse, reducing detergent residues.
Some programs cannot select this function.

Tub Clean function

The "Tub Clean" function can clean the inner barrel after long time usage. After the setting is successful, "2H" will be displayed, and the remaining time will be displayed after starting.

- When using this function, the drum should be empty.

Hand Wash function

Select "Hand Wash" function, it works by the imitation of hand wash by water flow for enhanced washing performances.

Some programs cannot select this function.

This function cannot be combined with "Gentle", "Rapid", "Tub clean" or "Heavy" functions.

Rinse+ function

Select the "Rinse+" function, it works by using running fresh water for last rinse.

For minimizing detergent residues.

Some programs cannot set this function.

This function cannot be combined with the "Rapid" function.

General Usage

1.Preparations

- ① Connect and lay down the drain hose.
- ② Connect the water inlet hose to the water tap.
 - Before turning on the water tap, make sure the screws of the universal joint are tightened. If the screws are loose, it may cause water leakage.
- ③ Plug the power cord into a power socket.
- ④ Put in laundry.

2.Add detergent in the detergent dispenser box or directly into the tub.







3.Press the "Power On/Off" button to turn on the power and select the desired program and/or function.

4.Close the lid and press the "Start/Pause" button.

- Sensor will automatically detects the amount of cloth.
- Note: For "Mixed", "eCotton", "Stain", "Quick" programs.
- If the door of the washing machine is not closed, the washing machine will not be able to complete the washing process normally and there will be alarm alert.
 - Using too much detergent may cause residues in laundry, while using too little detergent may not making washing clean.
 - You can use softener, by pouring softener slowly into Softener Dispenser before washing.

Program	Function selection						Special Function	
	Rapid	Heavy	Gentle	Add Soak	Add Rinse	Tub	Hand wash	Rinse Plus
Mixed	●	●	●	●	●	○	●	●
eCotton	○	●	●	●	●	○	○	●
Stainwash	○	○	●	●	●	○	○	●
Quick	○	●	●	●	●	○	○	●
Spin	○	○	○	○	○	○	○	○
Rinse+spin	○	●	●	○	●	○	○	●
Tub clean	○	○	○	○	○	●	○	○

Hints & Tips

<ul style="list-style-type: none"> Please wash colored and white, different sized laundry separately. Please do the laundry by following the label instructions. 	<ul style="list-style-type: none"> Please remove the dirt on your clothes first. Make sure pockets are empty. (Items such as nails, coins, etc. may damage clothes or the washing machine, generate extra noise or cause malfunction.) 	<ul style="list-style-type: none"> Please put large and heavy clothes that are easy to float on the water first. If the laundry floats out of the water, pause the washing program and press the laundry into the water first. 
<ul style="list-style-type: none"> Fasten the loose strap, buttons on the clothes. 	<ul style="list-style-type: none"> When washing delicate fabrics, such as lingerie, laced items, nylon and thin fiber fabrics, etc., they should be placed in a laundry bag with a zip. 	<ul style="list-style-type: none"> Clothing that is prone to threading, please wash it by turning inside out. 

Cleaning & Maintenance

Clean the cabinet with a soft cloth

- Please do not spill water directly on the cabinet. Doing so may cause short circuit or electric shock.
- Please do not use a brush, glazing powder, gasoline, or other volatile materials to clean the washing machine. Doing so may damage the surface coating or plastic parts.
- The protective film on the surface of the cabinet can be retained or removed without affecting the normal use of the product.



Cleaning of the inlet valve (suggested once every six months)

- The accumulation of dirt will affect water flow, please remove the water inlet hose, take out the filter at the inlet valve, remove the dirt on the filter and reinstall it.



Troubleshooting Guide

When the following problems occur, the machine will detect the abnormal state and issue an electronic buzzer alarm for about 10 seconds, and the digital window will display the fault code as shown in the table below.

Note:

After checking each item and removing the fault, press the "Start / Pause" button, the fault display is cleared, and the washing machine will continue to run. If it is still abnormal, please unplug the power cord and call After-sales Service as soon as possible.

Failure type	Fault code	Points to check
Out of operation		<ul style="list-style-type: none"> Whether the power is connected? Whether the "Start / Pause" button is pressed? Whether delay time is set? Whether the fuse or current breaker of the power supply is intact? Whether there is a power outage?
No water intake or litter water inflow	E1	<ul style="list-style-type: none"> Whether the water tap is opened? Whether the water supply is cut off? Whether the water inlet hose and water inlet valve filter is blocked? Whether the water inlet hose of the washing machine is frozen? Whether the water pressure is too low and the water intake time is too long?
Drainage failure	E2	<ul style="list-style-type: none"> Whether the drain hose is laid down? Whether the drain outlet is too high (above 15cm)? Whether the drain outlet is blocked?
Not Spin	E3	<ul style="list-style-type: none"> Whether the laundry is unbalanced? Whether the washing machine is installed flat?
	E4	<ul style="list-style-type: none"> Whether the door is open?
Not Rinse	E5	<ul style="list-style-type: none"> Check if the child lock function is set? Whether the door is open?
Others	H	<ul style="list-style-type: none"> Please wait if the temperature in the barrel is high or the spinning speed is too high.
	EA Eb EC	<ul style="list-style-type: none"> Please press the "Power On/Off" button to turn off the power, unplug the power cord, and call our customer After-sales Service as soon as possible.
	E901 E902 E920 etc.	
Ed		

Non Failure Indications

1. During washing or rinsing, there is still water inletting. This is due to automatic water replenishment with a drop of water level.
2. At the beginning of spinning, the washing machine tub stops and rotates. This is an intermittent spinning process designed to achieve better performance.
3. At the beginning of spinning, the washing machine tub stops and rotates from time to time. This is an intermittent spinning process designed to achieve better performance.
4. Water inlet and rinsing sometimes occur during spinning process, this is due to the lean-correction of the clothes performed automatically.
5. After the spinning is over, there is a sound like water flow. This is the sound of the balance fluid flowing in the balance ring designed to reduce the spinning vibration.
6. If the power is cut off during the operation, then the operation cannot continue automatically after power is resumed, please reset the program.