

Whirlpool

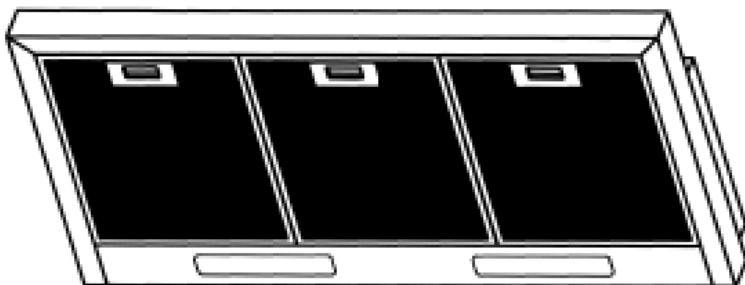

INSTRUCTION FOR USE

Slim Hood

WCO9FTS

INSTALLATION GUIDE

Read all installations before installing this
appliance



IMPORTANT SAFETY NOTICE

WARNING

The installation in this manual is intended for qualified installers, service technicians or persons with similar qualified background. Do not attempt to install this appliance yourself. Injury could result from installing the unit due to lack of appropriate electrical and technical background.

All electrical wiring must be properly installed, insulated and grounded. Overly accumulated grease in old duct work should be cleaned out or duct work should be replaced if necessary to avoid the possibility of a grease fire. Check all joints on duct work to ensure proper connection and all joints should be properly taped.



This appliance is marked according to the European directive 2002/96/EC on Waste Electrical and Electronic Equipment (WEEE).

By ensuring this product is disposed correctly, you will help prevent negative consequences for the environment and human health which could otherwise be caused by inappropriate waste handling.

The symbol on the product indicates that this product may not be treated as household waste. Instead it shall be handed over to the applicable collection point for the recycling of electrical and electronic equipment. Disposal must be carried out in accordance with local environmental regulations for waste disposal. For more detailed information about treatment, recovery and recycling of this product, please contact your local city office, your household waste disposal service or the shop where you purchased the product.

Installation

The right position of the hood should be 65cm above the level of your electrical hob or 75cm (see picture 3 & 4) if there are gas hobs.

The installation must take place accordingly .Put 2W LED lamp in the lamp holders. In order to avoid possible noise from shocks, we suggest you put a foam rubber tape on the back side, between the absorber plate and the wall or the upper side between the absorber plate and the closet, depending on how you set your hood.

Installation drawings are shown in following pages.

Fig.1

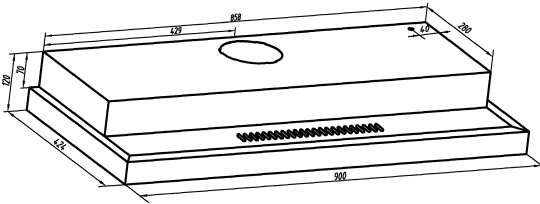

Fig.2

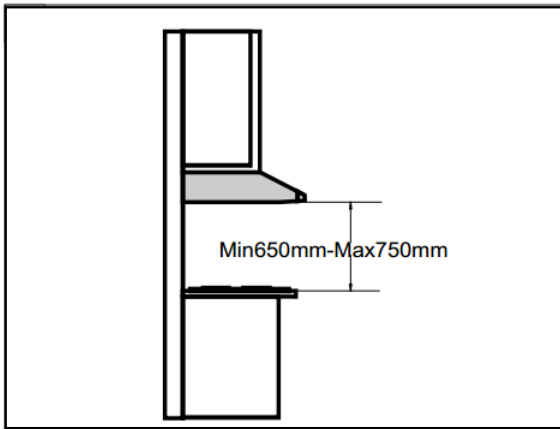
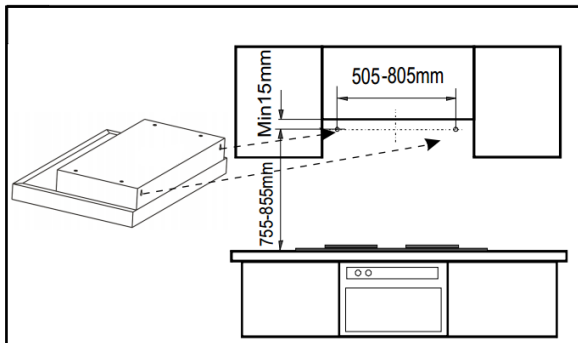

Fig.3



Connection to power

Make sure that the voltage of power network match with the one that is written on the type board of the absorber plate. The connection to power must be handled by an authorized technician. The power cord must include a bipolar switch with contact separation distance over or equal to 3mm. The device must be able to disconnect from the power supply.

Operation

In order for the hood to function effectively, you have to switch it on from the moment you switch on the hob. After you finish the cooking, you wait another 10 mins before switching it off. During cooking, leave the kitchen door half open. Do not leave the window of kitchen open as it may blow away the fumes from the hood.

-By pressing the key corresponding to "low (🌀)", "medium (🌀)" and "high speed (🌀)" to turn on the hood at low, medium and high speed.

- When the appliance and light are ON together or separately, press "Automatic Stop Timer -15 minutes (🔌)" the Automatic Stop Timer will start the 15 minutes count down. Indication light on the button (🔌) will flash for the duration. To stop the Automatic Stop Timer Function before 15 minutes time frame, press key (🔌) again.
- To turn on the light, press key "lamp (💡)".
- To turn off the light, press key "lamp (💡)" again.

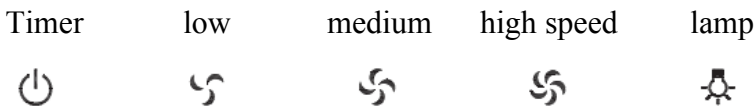

Fig.4

Maintenance

The hood should be washed by a sponge with warm water. Regular cleaning maintains the performance of your hood. And plug off before carry out any cleaning maintenance.

Filter cleaning or replacement

Attention: During filter cleaning or replacement procedure, the hood must be plug off.

In order to replace or clean the filter you have to:

1. Remove the aluminum filter by pressing the filter buttons.

Now you are able to change or clean the filter.

The aluminum filter should be washed by dishwasher or by hands every 30 days. Please make sure the filter is dry before you assemble them back.

Do not neglect to clean the aluminum filter regularly (every 2 months).

The filter which is not cleaned regularly is dangerous and can cause fire.

Fig.5

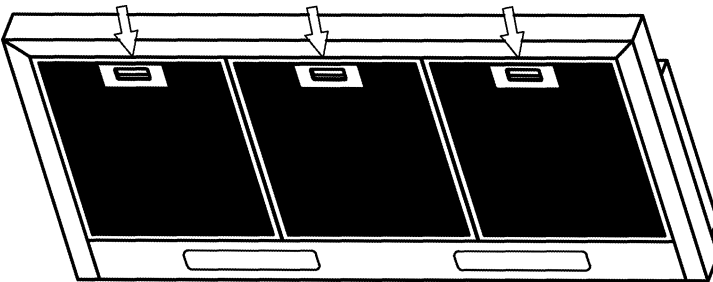

The active carbon filters purify the air that is replaced in the environment. The filters are not washable nor reusable and must be replaced every 4 months at most. The saturation of the active carbon filter depends on the frequency of use of the appliance, the type of cooking and the regularity of cleaning the aluminum filters.

Fig.6

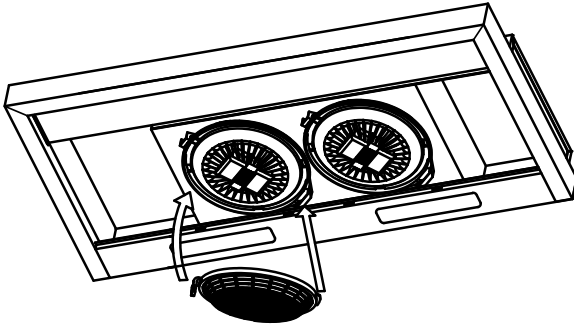

Lamp replacement

During lamp replacement procedure, the hood must be plug off. Use a one-edged screwdriver or any other appropriate tool to lift and remove the overhead light fixture. Replace the damaged lamp. Use only LED lamps as the original specification, avoiding contact with hands. Return the light fixture to its position (snap fastening). (Fig. 7)

Fig.7

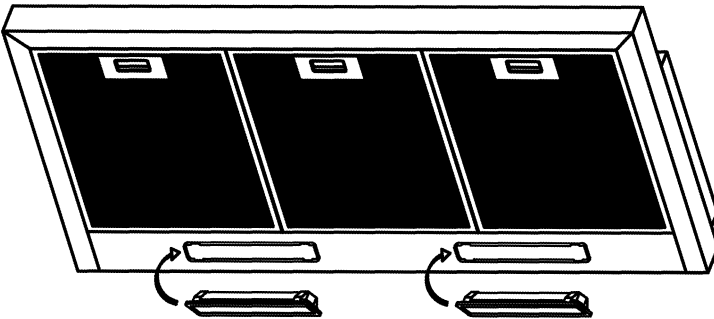

Attention

It will be dangerous in the following cases:

- Do not disassemble the grease filter when the hood is working.
- Do not touch the lamps or surfaces surrounding after the hoods have been working for a long time.
- Do not leave bare flames under the range hood, it may damage the filter or cause a fire.
- Deep fat fryer must be continuously monitored during use: overheated oil can burst into flame.
- Disconnect all the electricity before any maintenance work.
- This machine can't be operated by children or the weak.
- Children should be supervised to ensure that they do not play with the appliance.
- There is a fire risk if cleaning is not carried out in accordance with instructions.
- The discharge air must not be discharged into a flue which is used for exhausting fumes from appliances burning gas or other fuels.
- Only a qualified and trained service technician can undertake the work of installation and servicing.
- Only the suppliers' wire can be used to replace the broken wire.
- It is not allowed to disassemble the machine without authorization.

TECHNICAL DATA (WCO9FTS)

Electricity

Voltage	220-240	V
Frequency	50	Hz

Power

Total	204	W
Fan motors	200	W
Illumination	2x2	W

Installation Distance

Electric hob	650	mm
Gas hob	750	mm
Cable length	150	mm
Plug type	UK Plug with safety mark	

TROUBLE SHOOTING

The cooker hood may not work or work improperly. Before calling the After-sales service, switch off the appliance, unplug the power supply and refer to this guide to determine the problem.

Problem	Possible reason	Solution
Hood doesn't work	No electricity supply	Check the plug is connected
		Check that the main switch/circuit breaker/safety switch is turned on
Poor airflow	Aluminum grease filters clogged	Take off and clean filters when clogged Replace the filters
Motor running but no air flow	Butterfly valve jammed	Contact service department
Motor turns off after a few minutes	High temperature safety device activated	The kitchen is not sufficiently ventilated
	The hood is installed too near to the cooking stove	The hood must be at least 650mm from stove
Oil dripping onto stove	Aluminum grease filter saturated	Wash the aluminum grease filters
Whirring sound	Something in contact with fan blade	Contact service department



**PRODUCT WARRANTY
REGISTRATION**
(For Singapore customers only)



Thank you for choosing Whirlpool or Ariston.
Please register your warranty online within 15 days of purchase.

3 SIMPLE STEPS TO REGISTER:

- 1** Go to www.whirlpool.com.sg or www.aristonchannel.com.sg
- 2** Create an account with us. You can register warranty and check your registered products.
- 3** Key in your **Product model** and **Serial Number** to register!

For more information, please call our Customer Service Hotline **6250 6888** or email to helpdesk.sg@whirlpool.com.

IMPORTANT NOTICE:

Warranty is only valid and applicable to Whirlpool and Ariston products purchased from authorized dealers in Singapore. Please keep your ORIGINAL PURCHASE RECEIPT and present it for verification when required. Whirlpool Southeast Asia Pte reserves the right to reject the warranty claim not registered online. © Whirlpool Southeast Asia Pte