

SPECIFICATIONS

Model	WFRB802AHW	WFRB904AHW	WFRB1054AHW
Rated wash capacity	8.0kg	9.0kg	10.5kg
Rated spin capacity	8.0kg	9.0kg	10.5kg
Max current	10A	10A	10A
Rated voltage	220-240V/50Hz	220-240V/50Hz	220-240V/50Hz
Rated heating power	1700W	1700W	1700W
Rated power	1800W	1800W	1800W
Water pressure	0.03~1.0MPa	0.03~1.0MPa	0.03~1.0MPa
Product dimension	600x580x850	600x580x850	600x635x850
Weight	63kg	66kg	70kg

WARNING - This appliance must be earthed.

FOR WASHER PLUG 3 PIN (BS Standard Plug With 13 Amp Fuse)

The wires are coloured in accordance with the following code:
 Green/yellow: Earth Light Blue: Neutral Brown: Live

The wires in the appliance may not correspond with the coloured markings identifying the terminals in your plug, proceed as follow :

- The wire which is coloured green and yellow must be connected to the terminal in the plug which is marked with the letter E or by the earth symbol  or coloured green or green and yellow.
- The wire which is coloured light blue must be connected to the terminal which is marked with the letter N or coloured white.
- The wire which is coloured brown must be connected to the terminal which is marked with the letter L or coloured black.

FOLLOWING CAUTIONS ARE FOR WASHER USING DOUBLCORE CORD ONLY.

- If the 2-pin type socket-outlet has a grounding terminal, attach the end of the Grounding Wire to the terminal.
 - When grounding the washer, connect the grounding wire before plugging in the Power Cord.
 - If the 2-pin type socket-outlet has no grounding terminal, consult your nearest dealer or attach the end of Grounding Wire to a suitable grounding point, such as a metal water pipe.
- Never connect the Grounding Wire to a gas pipe.
- Unplug the Power Cord before disconnecting the Grounding Wire.

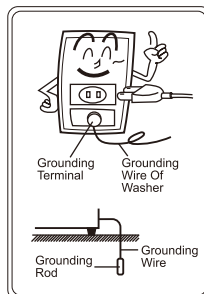

Whirlpool

INSTRUCTION MANUAL Drum Washer

WFRB802AHW
WFRB904AHW
WFRB1054AHW



Before operating this washing machine, please read these instructions carefully and completely.

CONTENTS

INSTRUCTION BEFORE WASHING

SAFETY NOTICE -----	2~3
INSTALLATION INSTRUCTIONS -----	4~6
NAME OF PARTS -----	7
ACCESSORIES -----	7

OPERATION INSTRUCTION

SPECIFICATION SHEET -----	8
LOCK AND UNLOCK METHOD -----	9
INTRODUCTION TO DETERGENT BOX -----	10
INTRODUCTION TO CONTROL PANEL -----	11~12
PROGRAM INTRODUCTION -----	13~14
VARIOUS FUNCTIONS -----	15

CLEAN AND MAINTENANCE

CLEAN AND MAINTENANCE -----	16
NON-BREAKDOWN CONDITION -----	17
TROUBLESHOOTING GUIDE -----	18



SAFETY NOTICE (be sure to observe)

- To protect the user and other people's health and property, be sure to observe the following safety notice.















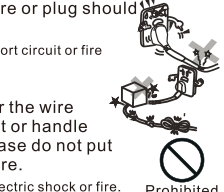

⚠ WARNINGS

please read this part of substance carefully for proper operation before using your machine.













- The precautions stated here are classified as "Warning" and "Attention" according to the damage and the emergency caused by misoperation, and are described respectively in line with the marks below.

 Warning	With no respect to mark, the misoperation may cause death or GBH.
 Attention	With no respect to mark, the misoperation may cause body harm or object damage.

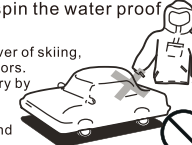
		
This mark indicates the content of warning or attention.	This mark indicates the prohibited action.	This mark indicates the compulsory action to be carried out.

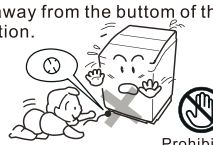
⚠ Warning	
<ul style="list-style-type: none">  Dismantling, repair or alterations should only be carried out by professional technician as otherwise you may be subjected to electric shock, may cause fire or injuries. 	<ul style="list-style-type: none"> This washing machine is equipped with the electricity wire with bielectrode grounding socket. The creepage protector shall be used if possible.  <p>To prevent electricity leak which may cause injuries.</p>
<ul style="list-style-type: none">  Electricity supply must be unplugged with dry hands. Otherwise, this may cause electric shock.  <p>Wet hands Prohibited</p>	<ul style="list-style-type: none">  Please use the single socket with special voltage and current which matches the marked specification. <p>Avoid sharing of the same socket with other appliances to prevent overloading.</p>
<ul style="list-style-type: none">  Damaged or loosen wire or plug should not be used. Otherwise electric shock, short circuit or fire may take place.  Do not damage wire. Do not damage or alter the wire forcibly bend, pull twist or handle the wire. Besides, please do not put weigh on or trap the wire. Damage of wire may case electric shock or fire.  <p>Prohibited</p>	<ul style="list-style-type: none">  Thoroughly wipe the power plug when dirt is adhering the prong or around the base of the prong. Failure to do so may cause a fire. <p>Clear</p>
<ul style="list-style-type: none">  Do not put water in direct contact with the unit during maintenance and repair. This may cause short circuit or electric shock.  <p>Prohibited</p>	<ul style="list-style-type: none">  Washing machine should not be installed in humid places or in places exposed to wind and rain. Otherwise, electricity leak causing electric shock or fire may occur.  <p>Prohibited</p>
<ul style="list-style-type: none">  Do not put gasoline, benzine, alcohol, thinner or fabrics with these stains into or near to the washing machine. To prevent fire or explosion which may cause injuries.  <p>Prohibited</p>	<ul style="list-style-type: none">  This washing machine is strictly prohibited to get close to the locations with candle, mosquito-repellent incense, dog-end, or other kinds of open flame. To avoid injuries caused by the lock damage.  Do not operate the machine when there is gas leak.  <p>Prohibited</p>

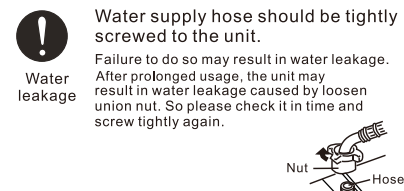
⚠ WARNINGS

<ul style="list-style-type: none"> Keep child away from the drum and do not place boxes or shelves next to the washing machine. children may fall into the basket resulting in injuries. This appliance is not intended for use by persons (including children) with reduced physical, sensory or mental capabilities, or lack of experience and knowledge, unless they have been given supervision or instruction concerning use of the appliance by a person responsible for their safety. 	<ul style="list-style-type: none"> The glass door becomes hot in process of high-temperature washing . Do not touch the door when the machine is on. If you need to open the door during high-temperature washing program, wait until the temperature drop to safe standard, and the door will unlock automatically. Packing material may be dangerous to kids, please keep all packing material (plastic bag foam etc) far away from the kids. 
<h3>⚠ Attention</h3>	
<ul style="list-style-type: none"> Do not pull the wire from the socket when unplugging the unit. To avoid electric shock or fire caused by short circuit. 	<ul style="list-style-type: none"> Please unplug the unit when not using the unit for a long period of time. Electric shock or leakage may occur due to deformation of plastic parts of the unit. 
<ul style="list-style-type: none"> Electricity supply must be unplugged with dry hands during maintenance and repair. Otherwise, electric leakage causing injuries may occur. If the power cord or supply cord is damaged, the manufacturer or its service agent or similarly qualified person must replace it in order to avoid a hazard. 	<ul style="list-style-type: none"> Water of above 50°C should not be used for washing . Electric shock or leakage may occur due to deformation of plastic parts of the unit. 
<ul style="list-style-type: none"> Do not wash, rinse and spin the water proof fabric or cloth. e.g. Sleeping bag, raincoat, cover of skiing, utilities, bicycles, cars and motors. Otherwise this may lead to injury by abnormal vibration during spinning or damage the washing machine, wall, floor and clothes. 	<ul style="list-style-type: none"> Do not stand on or put weight on the top of the unit. Otherwise, deformation and damage may result causing injuries. Two people are required in moving or transportation. 
<ul style="list-style-type: none"> Keep hands and feet away from the bottom of the washing when it is motion. Ports in motion beneath the unit may cause injuries. 	<ul style="list-style-type: none"> Check water supply hose connection by turning on the water before washing. To prevent damages caused by possible water leakage due to loosen screw. The new hose-sets supplied with the appliances are to be used and old hose-sets should not be reused. Do not block the ventilation openings on the bottom of washer by carpeting when the washer is installed on a carpeted floor. 
<ul style="list-style-type: none"> Water supply hose should be tightly screwed to the unit. Failure to do so may result in water leakage. After prolonged usage, the unit may result in water leakage caused by loosen union nut. So please check it in time and screw tightly again. 	<ul style="list-style-type: none"> Please turn off the water tap when not using the unit. To prevent damages caused by water leakage. 

INSTALLATION INSTRUCTIONS

Transportation

Two people are needed to carry the machine. One person on one side carries the machine by holding the machine feet.

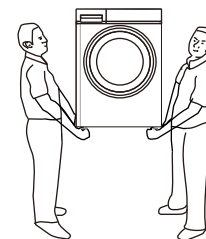

Location of washer



1. On the sloping ground
2. On the platform and the bracket
3. On the concavo - convex ground

Washing machine must be installed on the ground which must be hard, flat and skidproof . Please do not lay the washing machine on the soft blanket or wooden floor. It is forbidden to lay the washing machine on the platform or the bracket.

Remove the bolt used to fix the machine in transportation

To protect the machine in transportation, there are 4 bolts inserted into the inner part of the machine. Remove these bolts before use. (otherwise there will be strong shock, noise, and disfunction in spin process.)

1. Unscrew the bolts that are fixed before transportation by spanner(4 bolts)
 2. Remove the bolts horizontally.
 3. Fit the lid into the holes .
- Let the sales force or professional maintenance worker to install the machine.
 - Keep the dismantled bolts carefully , you will need them during house moving.
 - As the picture shows, please be sure to confirm that the base protection device is not stuck at the bottom of the washing machine before use, otherwise it will affect the normal use of washing machine.

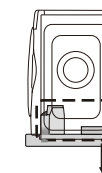
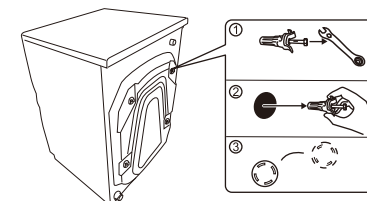

Base protection device

Adjust the machine horizontally

There will be strong shock, noise, and disfunction in operation if the washing machine is not steadily installed. Please adjust the front adjustable Leg.

Methods are as follows:

1. Check whether the washer is on a level surface using a plumb line as shown in the attached images.
- The washer is on level ground floor if the Frame line of washer is parallel with the plumb line.
2. Adjust the Adjustable Leg of washer if necessary to make the washer level as shown in the Beside figure.
3. Put your hands on the washer diagonally, press and shake the washer slightly to make sure that the washer is steady.

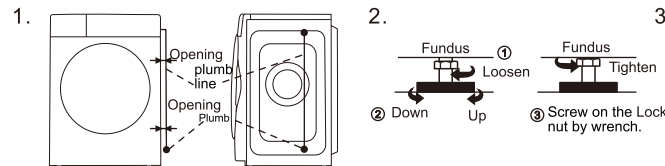

INSTALLATION INSTRUCTIONS

Connecting the Supply Hose

Attaching the "Magic" Hose Joint to a Faucet

Faucet: Type A :is the most suitable

Type B : The length of the mouth of the faucet needs to be at least 16mm.
If it is less than 16mm, the "Magic" Hose Joint can not be installed.

Type C :It may cause water leaking.

CAUTIONS:

- Do not use water which is hotter than 50°C.
- If your faucet is not suitable, please consult your dealer.

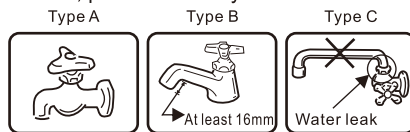

How to Attach the " Magic " Hose Joint

- Loosen the four screws and slide the top of the "Magic" Hose Joint (section A in the figure) onto the faucet. Then, securely tighten the four screws provided with the "Magic" Hose Joint by using a screwdriver to secure the top of the joint to the faucet.
- Remove the CAUTION label from the "Magic" Hose Joint.
- Turn the male coupler on the joint (section B in the figure) clockwise to attach it securely to the top of the joint (section A in the figure).

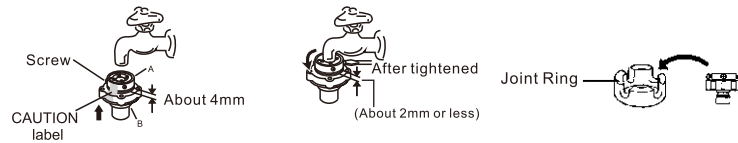

CAUTIONS:

If outer diameter of faucet is larger than calibre of the Joint Ring, loosen the four screws and remove the Joint Ring from the "Magic" Hose Joint.

Installing Water Supply Hose to the Washer

Turn the nut clockwise till the nut is tight while holding the hose.

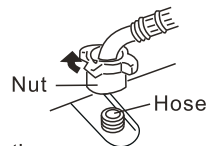

Turn the nut counterclockwise after turning the faucet off when you want to detach the water supply hose.

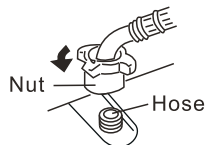

INSTALLATION INSTRUCTIONS

CONNECTION OF DRAIN HOSE

- When washing machine does not work, put drain hose at back of washing machine. (as pic 1 shows)
- When washing machine works, put drain hose into drainage pond (as pic 2 shows); you can also put end of drain hose into sewer, leaving space between end of drain hose and sewer elbow to avoid difficulty in draining water out of washing machine.
- Clean filter in pump periodically to keep washing machine working normally.

Note: Do not take off drain hose to avoid drainage problems.

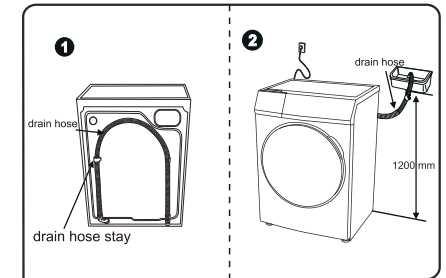

NAME OF PARTS

ATTENTION

- We suggest the user to run the tub clean program before the first wash.
- Don't forget to close the water tap and take down the power plug to avoid any flood and fire disaster.

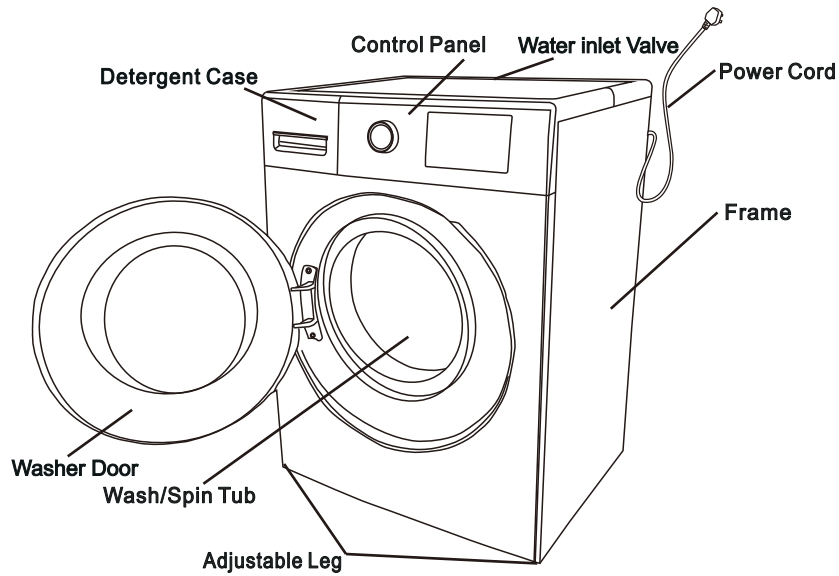

SPECIFICATION SHEET

Model	WFRB802AHW	WFRB904AHW	WFRB1054AHW
Rated wash capacity	8.0kg	9.0kg	10.5kg
Rated spin capacity	8.0kg	9.0kg	10.5kg
Max current	10A	10A	10A
Rated voltage	220-240V/50Hz	220-240V/50Hz	220-240V/50Hz
Rated heating power	1700W	1700W	1700W
Rated power	1800W	1800W	1800W
Water pressure	0.03~1.0MPa	0.03~1.0MPa	0.03~1.0MPa
Product dimension	600x580x850	600x580x850	600x635x850
Weight	63kg	66kg	70kg

ACCESSORIES

Instruction manual	Water Supply Hose	Lid (4Piece)	Spanner	Product Warranty Certificate

LOCK AND UNLOCK METHOD

DOOR LOCK

When the machine is working, the door locks automatically. It can't be opened.

UNLOCK

When the machine is working, press the "START/STOP" button.
The door can be unlocked after inner tub stops spinning.

- If power plug is removed directly or if there is a power cut when the machine is running, the door can't be unlocked automatically.
- If door is opened when the machine is in operation, the froth may spillover. Clean with towel thoroughly.
- The user can't open the door when the machine is running with a high working temperature.
- The user can't open the door when the water temperature is high.

INTRODUCTION TO EACH COMPARTMENT OF DETERGENT BOX

WASHING POWDER ● DETERGENT

- This compartment is for filling up with powder or liquid detergent.
- If powder detergent is being used, please mix with a small amount of water to dissolve the detergent before placing into compartment.

SOFTENER

- Please input the softener before washing. It will be injected automatically before last rinse.
- If using the concentrated softener, please input it after dilution with water accordingly.

- Please use the specified detergent for front loading washing machine.
- Please don't use superfluous detergent. Otherwise it will cause more froth and influence the rinse performance or cause malfunction.
- Please refer to user guide for proper use of detergent and apply according to the clothes type, color, water temperature and soil level.
- Using moderate detergent can have better washing performance and protect the environment.
- Please don't use excess washing powder to prevent remnants on door gasket at end of wash cycle.

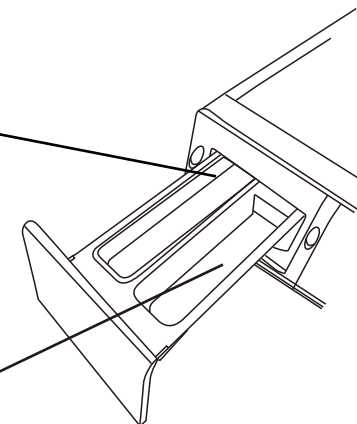

INTRODUCTION TO THE CONTROL PANEL

The distribution

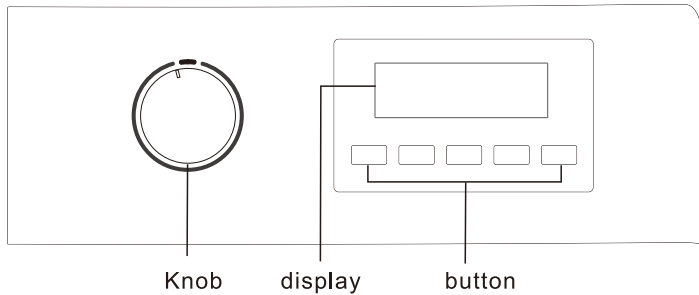

Start/Stop

- Press button once to start and press again to stop.



Power button

- This is for turning on / off the machine.
When the program finishes, machine switches off automatically.



Program choice

- Choose a suitable program according to clothes type and dirt level.

Display window introduction

- When power is turned on, it will display the spin speed and other functions.
- When machine is in operation, it will display the time remaining.
- When machine breakdowns, it will display the error code.

Temperature button

- Set the washing temperature according to the clothes type.
- The temperature setting range is different among programs. Some of them have range limitations.

INTRODUCTION TO THE CONTROL PANEL

Spin speed button

- Set the spin speed according to user's requirement.
- Some programs have limitations on setting the spin speed.

Delay button

- This option makes it possible for users to define the end of the washing time for up to 24 hours.

Time wash button

- Users can choose between various washing time.

PROGRAM INTRODUCTION

Mixed	Mix wash of cotton and synthetic fabric
Cotton	Wash of heat-resistant cotton or linen fabric
ECO	Economical wash program to consume less water and electricity
Jeans	Wash of jeans
Wool	Wash of wool which can be washed by machine
Soak	Wash of deep dirty blanket and large size clothes
Down	Wash of down jacket which can be washed by machine
Quick wash	Wash of lightly soiled clothes
Colors	Wash of clothes with deep color or light color
Delicates	Wash of clothes which are easily damaged e.g. silk, satin
Shirt	For non-ironed shirts or blouses made of cotton, linen or synthetic materials
Kids wear	Wash of kids wear
Rinse + spin	For clothes which require only rinse and spin
Spin	To spin laundry and drain water in drum
Drum clean	For cleaning the drum

The programme used for the evaluation of models under the mandatory Water Efficiency Labelling Scheme (WELS) and the recommended Washing Programme for soiled clothes is as follows : ECO Default temperature 30°C

PROGRAM INTRODUCTION

User instruction for the normal clothes

Method

1. Preparation
 - Put the clothes in and close the door.
 - Put the detergent or washing powder into the detergent box.
 - Switch on the water tap, connect the drain-pipe, plug the power supply.
2. Switch on the power.
3. Choose the suitable program.
4. Choose the suitable button.
5. Press the “Start/Stop” button.
6. When washing ends, the buzzer will sound.

Instruction to wool program

Method

- Turn on machine and choose the wool program.

Attention

- Please confirm the washing mark on the clothes before washing.
- When washing ends, please take the clothes out immediately for airing in order to avoid clothes deformation.
- The temperature can't be more than 40 degrees to avoid spoiling the fabrics.
- Using the wool detergent can improve the washing performance.
- Make Separate washing for light colour clothes and dark colour clothes.

ECO program

Method

- Turn on machine and choose the ECO program.

Attention

- This program features an energy and water saving wash performance.
- When cycle completes, remove clothes immediately.
- It is suggested to use defaulted water temperature and spin speed.

VARIOUS FUNCTIONS

Introduction to Delay wash

Method

- Turn on machine and choose the suitable program according to user's requirement.
Press the delay button to determine the finishing time.
Press the start/stop button to start-up the delay wash function.
(Delay time has one hour interval and goes to a maximum of 24 hours.)

Attention

- If users need to amend the time, please press power button and reset.
- After selection, users can still cancel it by pressing on power button.
- Once delay wash has been confirmed, press the delay button. The set time will be displayed for 5 seconds.
- Delay wash duration differs based on water pressure, laundry load, clothes type, water temperature.

Cancel the buzzer

There is no buzzer when cycle ends.

Set/Cancel method

Turn on machine and press "Start/Stop" button till buzzer sounds. When button is released, the buzzer sound will be deactivated. To reactive, repeat steps.

CHILD PROTECTION FUNCTION

If machine door is opened before program starts the machine will activate the child protection function automatically when working. Firstly, the door will be opened and motor will be running for a while. Next, the door will be unlocked for a while till working again. If the door is opened during the waiting time, the machine will stop automatically.

CHILD LOCK FUNCTION

User can activate the child lock function in order to prevent children from playing with machine during operation. Both the door and program buttons will be locked automatically. Door will be unlocked once function has been deactivated.

Set/Cancel method

Turn on machine and press "temperature" button for 3 seconds till the buzzer sounds. The child lock function is activated. Repeat steps to deactivate.

CLEANING AND MAINTENANCE

- Proper cleaning and maintenance can prolong the lifespan of machine.
- Please unplug the power supply during maintenance.

MACHINE BODY

- Please use a soft cloth to clean the body after washing every time. If there is too much dirt, please apply some detergent or soap water on the cloth to clean the body.
- Please don't use water to flush the machine directly.
- Dirty powder, diluent, petrol and alcohol are forbidden for use to clean the machine.

DOOR GASKET

Please use cloth to clean the gasket after washing every time. If there are brooch or other sundries, please ensure to remove.

DETERGENT BOX CLEANING

Please clean the detergent box periodically. Remove the box and clean it with water.

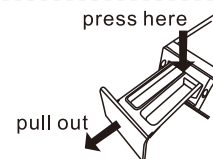

INLET VALVE CLEANING (RECOMMENDED ONCE EVERY SIX MONTHS)

1. Take out the inlet pipe
2. Take out the lint filter screen
3. Use a toothbrush to clean the lint filter screen and then assemble it again
4. Connect the inlet pipe after cleaning.



TUB CLEANING (RECOMMENDED MONTHLY)

There may be dirt residue resting in the tub after prolonged usage. The tub clean function can clean the inner and external tub. (Attention: please don't put in clothes and detergent when using this program.)

CLEANING PUMP FILTER (RECOMMENDED MONTHLY)

1. Insert coin into the groove of pump and press it. The filter cover can be opened. (Attention: If there is hot water in the machine, please wait for water to cool down before opening the filter.)
2. Remove the filter in an anticlockwise direction.
3. Wash the filter with water.
4. Assemble the filter into the pump in a clockwise direction.

- Attention:
1. The filter should be assembled tightly in order to avoid water leakage.
 2. Please don't clean the filter when the machine is working.

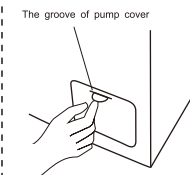

NON-FALLURE CONDITION

Condition	Possible Reason
Door can't be opened	<ul style="list-style-type: none"> Water temperature is too high or power cut. Child lock activated. The clothes are clamped between door and gasket.
Peculiar smell	<ul style="list-style-type: none"> Due to rubber components, the rubber smell lingers at the beginning.
No water	<ul style="list-style-type: none"> Ensure that tap is turned on. Ensure filter is not blocked.
Water is being drained during wash cycle	<ul style="list-style-type: none"> Too much bubbly detergent
Residual time change	<ul style="list-style-type: none"> Washing machine will automatically fill water to ensure clothes are evenly distributed. The time remaining is calculated based on 15L/min inflow. So according to different water pressure, time will be prolonged or shortened. Washing machine will prolong drying time if clothes are not evenly distributed.
Abnormal sound during spinning	<ul style="list-style-type: none"> Is power line connect to cabinet? Is the carriage bolts have been removed? Is there a hairpin, coins or other foreign objects stuck in the drum?
Failure to work after power failure	<ul style="list-style-type: none"> If machine fails to operate after power failure, press "power turn on/ off" to recover and reset program.
Emergency door opening	<ul style="list-style-type: none"> During power failure or appliance failure, the door remains locked. To remove the clothes, unplug the power cord and wait for the inner drum to stop before pulling down the emergency rope located on bottom right corner of cabinet. Observe a slight nose before you can open the door. Confirm that water level is below the bucket and water temperature is below 60°C in advance.

TROUBLESHOOTING GUIDE

Error Code	Reason	Inspection factors	solution
No display	Out of operation	<ul style="list-style-type: none"> whether the outlet have electricity whether the outlet is plugged in power cut or not leakage protector switch off or not 	
E11	No water	<ul style="list-style-type: none"> Whether tap is turned on or off Whether filter has any blockage Whether water has stopped flowing or not 	Press the Start/ Pause button
E12	Draining failure	<ul style="list-style-type: none"> Whether drain pipe is in the right place Whether drain height is too high or low Whether there is blockage in drain-pipe 	Press Start/Pause Button
H	Door can't be opened	<ul style="list-style-type: none"> Make sure water temperature has cooled down. Suspension of drying 	Door unlocks automatically once temperature has dropped to safe range.
U3	Spinning function doesn't work	<ul style="list-style-type: none"> Ensure water is placed stably. Avoid overloading with too much clothes. Reduce load. Avoid rolling blanket up into machine. 	Add 2 pieces of cloth and press the Start/pause
U4	Door not closed		Close the door, wait for "locked" light to be activated before pressing "Start/Pause" to continue
03H	Door cannot be opened	<ul style="list-style-type: none"> Is drum clean function being activated? 	Press "Start/Pause" or "Power On/Off" and wait for a few minutes for door to unlock automatically. It is not recommended for consumers to unplug to power cord in this situation.
Other code	Alarm		Press "Start/ Pause" to resume operation. If problem persists, contact the service center.